



UNION INTERNATIONALE
DE PENTATHLON MODERNE

COMPETITION RULES AND REGULATIONS

as of 1 January 2022





UIPM COMPETITION RULES AND REGULATIONS
as of 1 January 2022

TABLE OF CONTENTS

MORE
THAN
SPORT

COMPETITION RULES

01	MP - General Aspects	Pg. 6
02	MP - Riding	Pg. 30
03	MP - Fencing	Pg. 48
04	MP - Swimming	Pg. 70
05	MP - Laser Run	Pg. 80
06	Masters	Pg. 108
07	UIPM - Biathlon	Pg. 122
08	UIPM - Triathlon	Pg. 130

EQUIPMENT REGULATIONS

01	MP - General Aspects	Pg. 139
02	MP - Riding	Pg. 140
03	MP - Fencing	Pg. 144
04	MP - Swimming	Pg. 158
05	MP - Laser Run	Pg. 160

GENERAL ASPECTS

ABBREVIATIONS

BAD	Business Affairs Delegate	NF	National Federation
CCh	Continental Championships	NTO	National Technical Observer
CISM	Conseil Internationale du Sport Militaire	OG	Olympic Games
EB	Executive Board	PWR	Pentathlon World Ranking
FOP	Field of Play	TC	Technical Committee
HQ	Headquarters	TD	Technical Delegate
IJ	International Judges	TM	Technical Meeting
IOC	International Olympic Committee	UIPM	Union Internationale de Pentathlon Moderne
LOC	Local Organising Committee	WCC	World Cup Competition
Mins	minutes	WCF	World Cup Final
MD	Medical Delegate	WCh	World Championships
MP	Modern Pentathlon	YOG	Youth Olympic Games

PART A

MODERN PENTATHLON - CONTENTS

1.1 SPHERE OF APPLICATION

1.2 AGE GROUPS

1 Age Groups

2 Calculating age

1.3 THE EVENTS

1 The Five Disciplines

2 Disciplines in Youth Competitions

1.4 CATEGORIES

1 The Official UIPM
Competitions in Modern
Pentathlon

2 UIPM TD/NTO Control

3 OG and YOG

1.5 FORMATS

1.6 ORDER OF THE EVENTS

1 One Day Competitions

2 Traditional Competitions

3 Relay Competitions

2 Victory Ceremony

1 Individual Competitions

PART B

THE COMPETITIONS

1.7 TYPES OF COMPETITIONS

1 UIPM Category "A"
Competitions

2 UIPM Category "B"
Competitions

3 UIPM Category "C" Competitions

1.8 APPLICATIONS FOR UIPM COMPETITIONS

1 World Championships, World
Cup Series, Champion of
Champions

2 Continental and Regional
Championships

3 World Ranking Competitions

4 Other Competitions

1.9 ASSIGNMENT OF UIPM COMPETITIONS

1 Assignment

2 Declaration of Duties Signature

3 Annual UIPM Calendar

1.10 INVITATIONS

1 Invitation Schedule

2 Items in the Invitation

PART C**1.11
PROGRAMME OF
EVENTS AT UIPM
COMPETITIONS****1.12
PENTATHLETES
PARTICIPATION****1.13
PARTICIPATION OF
OFFICIAL****1.14
ENTRIES AND
ACCREDITATION****1.15 FINANCE****PREPARATION OF THE COMPETITIONS**

- | | | | |
|---|--|---|--|
| 1 | World Championships for Individuals | 3 | World Cup Series |
| 2 | World Championships for Relay | | |
| 1 | UIPM International Licence | 6 | Participation in Champion of Champions |
| 2 | Participation in World Championships for Individuals | 7 | Participation in Continental Championships |
| 3 | Participation in World Championships for Relay | 8 | Participation in OG and YOG Qualification Competitions |
| 4 | Participation in World Cup Series | | |
| 5 | Participation in World Ranking Competitions | | |
| 1 | Number of Officials | 2 | Other Persons |
| 1 | Dates for Entries | 4 | Substitute Athletes |
| 2 | Final Entries | 5 | NF Failing of Presentation |
| 3 | Bank Transfer | | |
| 1 | Cover of Costs | 3 | Accommodation Package |
| 2 | Accreditation Fee | 4 | Category "A" Competitions |

PART D**1.16
COMPETITION
AUTHORITIES****1.17
START LIST AND
START ORDER****1.18
COMPETITION
RESULTS****THE CONDUCT OF THE COMPETITIONS**

- | | | | |
|---|---|---|--|
| 1 | UIPM Technical Delegates | 5 | UIPM Business Affairs Delegates |
| 2 | UIPM National Technical Observer | 6 | Jury of Appeal |
| 3 | UIPM International Judges | 7 | Local Organising Committee (LOC) |
| 4 | UIPM Medical Delegates | 8 | Technical Meeting |
| 1 | Athletes Order inside the Team in Relay | 2 | Publication of the Start Lists |
| 1 | Modern Pentathlon Points | 5 | Team Classification in an Individual Competition |
| 2 | Displaying Results | 6 | Prizes and Awards |
| 3 | Final Positions and Points | | |
| 4 | Ties | | |

PART E

1.19 PENTATHLON WORLD RANKING (PWR) LISTS

1.20 MODERN PENTATHLON WORLD RECORDS

REGISTRATION OF THE PERFORMANCES

- | | | | |
|---|-----------------------------|---|----------------------------|
| 1 | Official List | 3 | Tie-Breaker Applied to PWR |
| 2 | Levels of UIPM Competitions | 4 | World Cup Standing |

PART F

1.21 SAFETY

1.22 OBLIGATION

1.23 DISCIPLINE RULES AND PROCEDURES

SAFETY AND DISCIPLINE

- | | | | |
|---|---|----|--|
| 1 | Responsibility of Pentathletes | 4 | Behaviour |
| 2 | Safety Measures and
LOC Responsibilities | 5 | Entrance in the FOP |
| 3 | Equipment | 6 | Restricted Entrance |
| 1 | Declarations | 5 | Anti-Doping |
| 2 | Clothing | 6 | Insurance |
| 3 | Equipment and Equipment
Control | 7 | Smoking |
| 4 | Start Numbers | 6 | Decisions on Penalties |
| 1 | Disciplinary Actions | 7 | Elimination and
Disqualification |
| 2 | Penalties for Athletes | 8 | Verbal Complaints |
| 3 | Punishments for Athletes | 9 | Protests |
| 4 | Disciplinary Measures to
Other Persons | 10 | Interruptions Caused by
Protests or Appeals |
| 5 | Sanctions on NFs and LOCs | | |

PART G

Appendix 1

ANNEXES

PWR POINTS

1

GENERAL ASPECTS

PART A

MODERN PENTATHLON

1.1 SPHERE OF APPLICATION

The following rules must be applied at all official UIPM competitions classified as Category "A" and "B", and are recommended for application as far as reasonable and feasible in Category "C" competitions.

1.2 AGE GROUPS

When not explicitly stated otherwise, these rules relate to all age groups, which are senior, junior, youth and masters, both for men and women.

1.2.1 Age groups are as follows:

8 and younger	Under 9
9 – 10 years	Under 11
11 – 12 years	Under 13
13 – 14 years	Under 15
15 – 16 years	Under 17
17 – 18 years	Under 19
19 – 21 years	Juniors
22 and over	Seniors
30 – 39 years	Masters 30+
40 – 49 years	Masters 40+
50 - 59 years	Masters 50+
60 - 69 years	Masters 60+
70 and over	Masters 70+

1.2.2 Calculating age

- i) The age of the pentathlete will be counted by subtracting the year of birth from the year of the competition. Months and days will not be taken into account.
- ii) Except for Masters competitions, a pentathlete may compete in the age group immediately higher than his age group. With permission from the competent national body, a pentathlete may compete in any higher age group.

1.3 THE EVENTS

1.3.1

The five disciplines of a Modern Pentathlon competition are organised in four events: Riding, Fencing, Swimming and Laser Run (Shooting and Running). Combinations of the different MP disciplines include UIPM Biathlon (Run-Swim), UIPM Triathlon (Shoot-Run-Swim) and Modern Tetrathlon (any combination of four of the five Modern Pentathlon disciplines).

1.3.2 Disciplines in Youth competitions

- i) At Under 19 competitions, 4 disciplines (without Riding) are obligatory.
- ii) For Under 17 competitions, Swimming and Laser Run are obligatory.
- iii) For all other Youth competitions, only Swimming and Running are obligatory
- iv) The LOC may include one or more of the other events if wished.

1.4 CATEGORIES

1.4.1 Official UIPM competitions in Modern Pentathlon are:

- Category A: Olympic Games, World Championships, Continental Championships and Games, World Cups and World Cup Final, Champion of Champions, CISM World Championships.
- Category B: Regional Championships and Games, World Masters Championships and Continental Master Championships and other World Ranking Competitions.
- Category C: Other international competitions and international Championships of any kind organised by UIPM member federations. The LOC must have invited the required number of national federations to take part.

1.4.2 UIPM TD/NTO Control

Category "A" and "B" competitions fall under the obligatory control of UIPM TDs/NTOs. At Category "C" competitions a TD/NTO may be appointed if they meet the criteria set out at Article 1.19.2 ii).

1.4.3 Olympic Games and Youth Olympic Games

The rules for Category "A" competitions apply also to OG and YOG, as far as they do not conflict with the OG Qualification Rules that are agreed by UIPM EB and IOC Executive Board.

1.5 FORMATS

1.5.1 Individual "One Day" Competitions

Official UIPM Individual competitions are organised as one-day competitions. It is mandatory that all events take place in one site and within walking distance of each other. Team classification may also be included, using the Modern Pentathlon points from the individual classification.

1.5.2 Traditional Competitions

Senior, Junior, Youth and Masters competitions may be organised over one or two days or, in exceptional circumstances, as three-day competitions, if two days are required for the Riding.

1.5.3 Relay Competitions

A Relay team consists of 2 athletes. Relay competitions must take place as a one-day competition. In Category "A" competitions, Men's and Women's Relay take place over one day and the Mixed Relay over a second day. If the number of participating teams is too large, the UIPM TD and LOC may approve a third day of competition.

1.5.4

New models and formats of competitions used as test events during the next Olympic period (2022-2024) are decided by the UIPM EB and will be communicated by them in advance of each occasion.

1.6 ORDER OF THE EVENTS

1.6.1 Individual

- i) In the Finals of the Category "A" competitions the order of events must be as follows: Riding, Fencing Bonus Round, Swimming and Laser Run.
- ii) Except for Olympic Games and World Cup Final, Semi-finals of the Category "A" competitions will be organised without Riding and according to the sequence mentioned at Art.1.6.1 i).
- iii) After athletes qualified for Semi-finals in Category "A" competitions a single Fencing Ranking Round will be organised before the Semi-finals and will be valid for both Semi-finals and Finals. In the Olympic Games and World Cup Finals the Fencing Ranking Round must take place the previous day. Laser Run must always be organised with a handicap start.
- iv) In the qualifications for the Semi-finals of Category "A" competitions (four disciplines without Riding) and in all other competitions the order of events may be different and adjusted to the LOC's needs. However, in the qualifications for the Semi-finals of Category "A" competitions, Laser Run must be the final event.

1.6.2 Victory Ceremony

The Victory ceremony is conducted immediately after the final event whether there are protests or not. In Category "A" competitions, the LOC must play the national anthem of the Victor's country and display the national flags of the medalists. Athletes must wear their national uniform on the podium and without baseball caps or hats. Headscarves are permitted. Flags, mobile phones, cameras, electronic devices, bottles, items of sport equipment, political statements and accreditations are not allowed on the podium.

PART B**THE COMPETITIONS****1.7
TYPES OF
COMPETITIONS****1.7.1
UIPM Category "A"
Competitions**

- i) **Olympic Games and Youth Olympic Games**
OG and YOG are organised every four years for both genders in Individual events, and in the YOG with a Mixed Relay competition. Special qualification and participation rules are established between the IOC and UIPM. There are a limited number of participants.
- ii) **UIPM World Championships**
UIPM World Championships are organised annually for Individuals and Relays in Seniors, Juniors and Under 19 age groups. In principle, World Championships for Seniors, Juniors and Under 19 should be organised after the conclusion of the World Cup series. For Laser Run, Biathlon/Triathlon and Masters World Championships, refer to the sub-sport specific rules.
- iii) **World Cup Series**
Each year 4 – 6 World Cup competitions and a World Cup Final are organised over a period of 3 – 6 months. The whole series is called "the World Cup Series". These competitions are carried out on different continents. NFs may organise only one World Cup competition in each calendar year, in addition to the World Cup Final.
- iv) **Continental Championships**
Every UIPM Continental Confederation has the right to organise Continental Championships for Senior, Junior, Under 19 and Under 17 Championships. Relay competitions must be included. Continental Championships must not take place on the same dates as the World Cup series, World Championships or CISM World Championships.
Continental Championships, as well as all other regional competitions organised by UIPM confederations, fall under the application of the UIPM Rules and are an integral part of the annual UIPM Calendar. With the agreement of the Continental Confederation and the LOC, the organiser of the Continental Championships may open the Continental Senior, Junior, Under 19 and Under 17 Championships to athletes from other continents than the host continent.
If athlete(s) belonging to a continent other than the host continent win the competition, the Continental title and medals will be assigned to the first athlete(s) and team(s) from the host continent.
- v) **Champion of Champions**
The Champion of Champions competition is organised annually for Individuals and Mixed Relay. In principle, it is the last competition of the season. Participants are invited by UIPM according to specific criteria.
- vi) **CISM World Championships.**

**1.7.2
UIPM Category "B"
Competitions**

- i) **World Ranking Competitions**
World Ranking Competitions are official international competitions organised for Senior or Junior or Under 19 and are open to all eligible participants. They fall under the UIPM Rules and the supervision of a UIPM TD/NTO. They must be included in the annual UIPM Calendar. The results count towards the PWR.
- ii) **Regional Competitions.**
"Region" means the territory of more than one UIPM member federation. If a Regional Competition meets the criteria set out at paragraph 1.19.2 ii), a TD/ NTO must be appointed and the Regional Competition will become a World Ranking Competition.

1.7.3 UIPM Category "C" Competitions

This category includes such competitions as:

- i) Open national championships. If they meet the criteria set out at Article 1.19.2 and a TD/NTO is appointed, the national Championships will become a World Ranking Competition.
- ii) Masters competitions.
- iii) Laser Run and Biathlon/ Triathlon events.
- iv) certain Youth competitions.

1.8 APPLICATIONS FOR UIPM COMPETITIONS

1.8.1 World Championships, World Cup Series, Champion of Champions

Applications for UIPM World Championships, World Cup Finals, World Cups and Champion of Champions must be submitted by UIPM NFs or Bidding Cities to the UIPM EB through the UIPM HQ by completing specific, detailed bidding forms available from UIPM HQ. The TC will give its opinion and make proposals. Deadlines for receiving completed candidatures are set by the UIPM EB, three years prior to the event.

1.8.2 Continental and Regional Championships

Applications for Continental Championships and other Regional competitions must be submitted in writing to the President of the relevant Continental Confederation in accordance with deadlines set by the relevant Confederation, which for Continental Championships will be two years prior to the event.

1.8.3 World Ranking Competitions

Applications for World Ranking Competitions must be submitted in writing by e-mail to the Executive Board member for Sport, and the UIPM HQ no later than 60 days before the annual UIPM Congress in the year preceding the relevant competition. For World Ranking competitions to be eligible for Olympic ranking status, the deadline for submission is 12 months before the start of the Olympic Qualification period.

1.8.4 Other Competitions

For all other UIPM competitions, no application procedure is necessary.

1.9 ASSIGNMENT OF UIPM COMPETITIONS

1.9.1 Assignment

Venues of UIPM World Championships, World Cup Series and Champion of Champions competitions are awarded by the UIPM EB. Venues of World Ranking competitions are awarded by the UIPM TC. Venues of Continental Championships and Regional competitions are assigned by the body authorised by the Statutes of the relevant Continental Confederation.

1.9.2 Declaration of Duties - Signature

UIPM NFs/Bidding Cities that are awarded UIPM World Championships, World Cup Series and Champion of Champions are obliged to sign a Declaration of Duties and to abide by the signed bidding documentation.

1.9.3 Annual UIPM Calendar

An annual calendar of official UIPM competitions, as defined above, must be prepared and drawn up by the UIPM TC in co-operation with the UIPM HQ before Congress. The annual UIPM Calendar is submitted by the UIPM EB to the UIPM Congress. The UIPM HQ circulates the calendar to all NFs. The calendar must be continuously updated. The Calendar for Category A competitions and Olympic Qualification/ Ranking competitions is announced two years in advance.

1.10 INVITATIONS

1.10.1 Invitation Schedule

Invitations to take part in an official UIPM competition should be addressed and sent to all NFs concerned in good standing at least 90 days before the competition. The invitation letters are sent by UIPM HQ and/or the Continental Confederation. The official invitation has to be sent at the same time to the UIPM appointed TDs/NTOs and UIPM HQ.

1.10.2**Items in the Invitation**

The invitation form should clearly state the following:

- i) the format of the competitions,
- ii) the order of events,
- iii) the length and type of swimming pool,
- iv) the running surface and any requirement for special footwear,
- v) the nature, dimensions and surface of riding arena,
- vi) the nature and characteristics of the targets to be used,
- vii) the number of pentathletes and officials to be invited,
- viii) the date(s) and times of test jumping, TM, equipment controls and events,
- ix) the financial terms of entry (accommodation, etc.),
- x) the nature and extent of the organised training facilities,
- xi) the date for receipt and/or online registration of informative, preliminary and final entries, which shall be by name and UIPM ID number,
- xii) the relevant address, continuously operating telephone and e-mail of the LOC for the 72 hours before and during the competition,
- xiii) any relevant visa conditions,
- xiv) the laser pistol regulations in the relevant country in question.

PART C**THE PREPARATION OF THE COMPETITIONS****1.11****PROGRAMME OF
EVENTS AT UIPM
COMPETITIONS****1.11.1****World Championships
for Individuals
(Seniors, Juniors,
U19, U17)**

Day 1	Men's Qualification		Women's Qualification
Day 2	Women's Qualification	or	Men's Qualification
Day 3	Men's Semi-finals		Women's Semi-finals
Day 4	Women's Semi-finals		Men's Semi-finals
Day 5	Women's and Men's Finals		

A cultural programme suggested to be included during the rest day (if available) for each gender in the U19/U17 (Youth) World Championships.

In the qualifications for the Semi-finals, groups of 20–36 pentathletes are formed; Groups of up to 38 pentathletes are allowed if enough shooting positions are available. The maximum number of pentathletes from the same NF competing in the same group being 2. The third and further pentathletes from the same nation must be moved to the next group(s).

- i) Placing pentathletes into groups is made in accordance with the current PWR list, as follows:

Group A	Group B	Group C	Group D
1	2	3	4
8	7	6	5
9	10	11	12
16	15	14	13
17	18	etc.	

- ii) The following numbers of pentathletes qualify for the Semi-finals:
 - a) 2 groups - the top 15 from each group + 6 with the highest score of all groups
 - b) 3 groups - the top 10 from each group + 6 with the highest score of all groups
 - c) 4 groups - the top 8 from each group + 4 with the highest score of all groups

- iii) If a pentathlete withdraws from the Semi-finals and/or Final before the start due to an injury or sickness, the pentathlete will be replaced by the next pentathlete, not yet qualified, with the highest score in all groups.
- iv) 36 pentathletes compete in the Semi-finals split over two groups of 18 athletes. Depending on the number of the participating athletes, at the Continental Championships, Continental Games and further UIPM Category "B" and "C" competitions the number of athletes can vary (between 10-17), in the Semi-final. Placing of the athletes into two groups is made in accordance with the current PWR list, Art. 1.11.1 i) must be applied.
- v) 18 pentathletes compete in the Final. The following numbers of pentathletes qualify for the Final: the top 7 from each group + 4 with the highest score of both groups in the Semi-final.
- vi) World Championships for Individuals must have an individual and a team classification.
- vii) These rules apply also to the CCh.

1.11.2 World Relay Championships (Seniors, Juniors, U19, U17)

- i) A maximum of 24 teams compete in a one-day format.
- ii) A Mixed Relay team comprises one male pentathlete and one female pentathlete from the same nation.
- iii) These rules apply also to the CCh.

1.11.3 World Cup Series

- i) World Cup competitions are organised over three days for each gender for Individual and one day for Mixed Relay, six days in total. Individual Semi-finals are organised with 36 athletes split over two groups, and Finals are organised with 18 athletes. Art 1.11.1 must be applied. World Cup competitions are normally valid for individual placing only, but if LOC wishes, prizes may be awarded for team classification.
- ii) World Cup Finals are organised over five days: one day for the fencing ranking rounds for both genders, one day for men and another day for women Semi-finals, one day for Finals for both genders. A Mixed Relay must also be organised.

1.12 PENTATHLETES PARTICIPATION

1.12.1 UIPM International Licence

- i) Only pentathletes holding a UIPM International Licence are allowed to compete in Category "A" and "B" competitions.
- ii) Pentathletes without riding ability listed on their Licence uploaded to the UIPM portal by the competition registration deadline:
 - a) cannot compete in World Senior Championships or a World Cup Final. (Senior Licence) or World Junior Championships (Junior Licence).
 - b) may compete at World Cup competitions in the qualification for the Semi-final, but if they qualify for the Semi-Final, must relinquish their place to the next pentathlete not yet qualified with the highest score in all groups.
 - c) at all other events, may compete in all disciplines except the Riding.
- iii) UIPM will present to all National Federations the minimum riding ability requirements to issue Junior and Senior age categories riding certificates.

1.12.2 Participation in World Championships for Individuals

- i) Every NF has the right to enter 3 participants.
- ii) If the total number of entries is less than 108 pentathletes, a 4th pentathlete per nation may be invited to participate, until 108 entries are reached per gender. Priority for invitation of a 4th participant from a nation is first to the host nation followed by other nations in order based on the PWR current at the time of the invitation.

1.12.3 Participation in World Championships - Relay

Participation in the World Championships Relay is determined on the basis of the results of Continental Championships and the Relay PWR. NFs may enter different pentathletes than those entered in the World Championships Individual competition.

- i) The 6 Continents and the Host Nation are each guaranteed a team as follows:

* Africa	1 team	* Europe	8 teams
* America North and Central	3 teams	* Oceania	1 team
* America South	3 teams	* Host Federation	1 team
* Asia	3 teams	* Relay PWR	4 teams

Total: 24 teams

-
- ii) The NF whose Relay team became World Champions in the preceding year is included within these 24 teams. Its place is attributed to the quota of the continent where the NF is located.
 - iii) If one or more teams from one Continent renounces its right to take part in the Relay World Championships, the place must be assigned to the first reserve team of the same Continent and so on until all the free places are covered. If the Continent does not have a Relay Championships or does not have reserves, the place will be assigned to the Relay PWR list dated 60 days before the competition.
- 1.12.4**
Participation in World Cup Series
- i) Every NF has the right to enter 3 participants per gender.
 - ii) If the total number of entries is less than 108 pentathletes, a 4th pentathlete per nation may be invited to participate, until 108 entries are reached per gender. Priority for invitation of a 4th participant from a nation is first to the host nation followed by other nations in order based on the PWR current at the time of the invitation. If there are still free places, the host nation is allowed to participate with up to a maximum of 12 pentathletes.
 - iii) For the World Cup Final, the maximum number of participants per NF and gender is 3 pentathletes.
- 1.12.5**
Participation in World Ranking Competitions
- World Ranking Competitions are competitions for pentathletes to achieve points for PWR lists. The LOC must ensure the minimum number of participating NFs and pentathletes as specified in Article 1.19.2 ii) to make the competition valid for PWR.
- 1.12.6**
Participation in Champion of Champions
- 18 pentathletes per gender are invited by UIPM to compete in the Champion of Champions based on the criteria set by the UIPM EB. Continental and host nation representation is guaranteed.
- 1.12.7**
Participation in Continental Championships
- The rules of Articles 1.12.1, 1.12.2 and 1.12.5 will be applied to Continental Championships accordingly.
- 1.12.8**
Participation in Olympic or Youth Olympic Qualifying Competitions
- In competitions that are also direct Qualification Competitions for the Olympic Games or the Youth Olympic Games, the maximum number allowed is 4 pentathletes per gender per nation.
- In Olympic Ranking competitions, counting towards the Olympic Pentathlon World Ranking list (OPWR or YOPWR) the maximum number allowed is 4 pentathletes per nation per gender. If there are free places, the host nation may compete with 6 athletes per gender.
- Olympic Pentathlon World Ranking (OPWR or YOPWR) eligible competitions, which are not Continental Championships, must be open to all UIPM nations, organise Individuals for both genders with qualification and finals of 36; and have applied by the deadline to be included in the Olympic Ranking calendar.

1.13 **PARTICIPATION OF OFFICIALS**

- 1.13.1**
Number of Officials
- In UIPM competitions, each NF may be represented in each gender by a maximum of 2 officials when there are 2 or more pentathletes from that NF, or by 1 official when there is 1 pentathlete competing.
- 1.13.2**
Conditions for Other Persons
- Other persons may attend the competition with the agreement of the LOC under the financial conditions stated in Article 1.15.

1.14 ENTRIES AND ACCREDITATION

1.14.1 Dates for Entries

For UIPM Category "A" and "B" competitions, the deadline for receipt of preliminary entries, if requested by the LOC, is 6 weeks before the beginning of the competition and 30 days for final entries. If the deadline for final entries is missed, the NF or individual pentathlete is considered as non-participating and may be replaced by another NF or pentathlete upon invitation.

1.14.2 Final Entries

In the final entries, NFs must list the names of the pentathletes, reserves and officials attending the competition. No delegation may arrive at the competition with more than the invited number of pentathletes and officials including substitutes.

1.14.3 Bank Transfer

At the same time as submitting the Final Entry Forms all NFs must send to the Organising Nation/LOC by electronic bank transfer or other means, 30% of the total amount of their accommodation invoice, otherwise their reservation will not be guaranteed. If on arrival for the competition, the team has fewer athletes and/or officials than listed on their Final Entry Form and without informing the Organising Nation/LOC at least 7 days prior to their arrival, the NF will pay a fine to the Organising Nation/LOC of 200 Euros for each person not attending.

1.14.4 Substitute Athletes

If a NF intends to enter a substitute pentathlete listed in its final entry form in the competition, it must inform the LOC by e-mail or fax at least 24 hours before the TM. Final entries are used by the LOC and UIPM TD to prepare the Start Lists of the Individual qualification groups. Pentathletes not included in the final entries or not listed in an e-mailed or faxed amendment as starting pentathletes, will not be allowed to enter the competition.

1.14.5 NF Failing of Presentation

Following confirmation of the final entries, a NF must enter the competition with at least one pentathlete/team per confirmed gender or Relay. Any NF failing to take part after having sent their final entries will pay a fine of 600 Euros to the UIPM.

1.15 FINANCE

1.15.1 Covering of Costs

At UIPM competitions, the Organising Federation/LOC covers all costs of the competition. Costs of the competition do not include hosting (i.e. local transport, accommodation and meals) of the participants. However, the Organising Federation/LOC may offer an Accommodation Package as described in Section 1.15.3 below to cover hosting costs (local transport, accommodations and meals).

1.15.2 Accreditation Fee

In competitions in which the Organising Federation/LOC offers NF participants (pentathletes, coaches, accompanying persons) an Accommodation Package (pursuant to Section 1.15.3 below), any participant that does not select and pay for an Accommodation Package are obliged to pay an Accreditation Fee to the Organising Federation/LOC. In addition, in competitions where the Organising Federation/LOC does not offer an Accommodation Package, the Organising Federation/LOC may charge any participant an Accreditation Fee.

- i) The Accreditation fee entitles participants to access the official transportation from the Headquarters hotel to the competition sites and back, and to have lunch packets and water/refreshments during the competition.
- ii) The amount of the Accreditation fee is set at 75 Euros per day of Senior and Junior competitions and 50 Euros for Youth per competition day with a minimum payment of 4 days.

1.15.3 Accommodation package

If not financially covered by the Organising Federation/LOC, adequate lodging and meals at the lowest possible prices must be offered to all NFs and UIPM family. The accommodation package includes local transport, accommodation, meals and the same entitlements as the Accreditation Fee. NFs may then either

1.15.4 Category "A" Competitions

- i) accept the proposal of accommodation packages proposed by the LOC in the invitation, or
- ii) arrange their own accommodation, in which case they are obliged to pay only an Accreditation fee to the LOC.

For those UIPM Category "A" competitions which have been awarded through a bidding procedure, the financial details referenced in the bidding document will be applied to the competition irrespective of when the competition was awarded. A financial report must be submitted to the UIPM within 6 months after the end of the competition.

PART D

1.16 COMPETITION AUTHORITIES

1.16.1 UIPM Technical Delegates

- i) A UIPM TD is a qualified International Judge proposed by the UIPM TC and appointed by the UIPM EB. For Category "A" competitions TDs must be members of the TC. The UIPM TD is tasked to ensure that all UIPM competitions are run in conformity with the UIPM Rules and agreements. The UIPM TD supervises the work of the LOCs and has full control over the technical direction of the UIPM competitions.
- ii) It is recommended that a UIPM TD must not come from the host country. Between one and four TDs will be appointed depending on the level and size of the competition. For OG 3 TDs and YOG 2 TDs will be appointed. For competitions qualifying directly for OG or YOG a minimum of 2 TDs will be appointed.
- iii) The costs of travel and per diem, including travel days, of the UIPM TD are borne by UIPM. The costs of full board accommodation and local transportation are borne by the Organising Federation/LOC.
- iv) Within their overall authority UIPM TDs are tasked in particular:
 - a) to check as soon as possible the terms of the invitation to the relevant competition.
 - b) to inspect and approve the sites and equipment for the five events.
 - c) to inspect and approve the transport for participants offered by the LOC.
 - d) to cooperate with the LOC in the administration of the TM and ensure the latest information concerning competition rules are available.
 - e) to select horses for the riding event from those proposed by the LOC.
 - f) to supervise the draw of the horses and the arrangements for checking the clothing and equipment of the participants.
 - g) to ensure correct management of Jury of Appeal procedures.
 - h) to check the entries and prepare the groups together with the LOC.
 - i) to ensure the accuracy of the results of the competition, which shall be verified by their signature, and promptly send the results, as well as a final report, by email to the UIPM HQ and the Chairman of the TC.
 - j) to ensure that the LOC promptly sends these results to the UIPM website (www.pentathlon.org).

1.16.2 UIPM National Technical Observer

- i) In Category "B" or "C" competitions, a UIPM NTO, from the official UIPM Judges list may be appointed instead of a TD by the Chairperson of the UIPM Technical Committee.
- ii) A NTO must:
 - a) hold an International Judges Licence for all Sports.
 - b) live in the country or near to the place where the competition will take place.
 - c) be integrated in the national organiser's competition staff, so that they are usually present at international competitions organised in that nation.
 - d) guarantee their presence throughout the competition.

THE CONDUCT OF THE COMPETITIONS

The UIPM HQ will inform the LOCs on the UIPM appointed authorities at the earliest convenience.

1.16.3 UIPM International Judges

- iii) The per diem costs of the UIPM NTO are borne by UIPM. The costs of full board accommodation and local transportation are borne by the Organising Federation/LOC.
- iv) The NTO has the same obligations at competitions as the TD.
- i) A minimum of two and a maximum of nine persons depending on the level and size of the competition are selected from the official UIPM Judges list by the UIPM TC and approved by the UIPM EB to act as IJs in Category "A" and "B" competitions.
- ii) The UIPM IJ will be available to the Organising Federation/LOC in all events, but the UIPM IJ must be used in fencing, riding and Laser Run. No judge may officiate at a bout which includes a pentathlete from his own federation.
- iii) The NF of the IJ covers the costs of the flight ticket from the home country of the UIPM IJ to the place of the competition. UIPM covers the cost of per diem for working and travel days, for other expenses. The Organising Federation/LOC bears the costs of accommodation, meals, and local transportation.
- iv) UIPM International Judges have to qualify as defined in specific Technical Officials Guidelines.

1.16.4 UIPM Medical Delegates

- i) One MD is appointed by the Chair of the UIPM Medical Committee to UIPM World Championships and other major events to ensure compliance with UIPM Anti-Doping Procedures and UIPM Medical Rules, and to advise team captains who intend to administer drugs to sick or injured athletes, so as to ensure that no substance or method forbidden by the WADA Code is used by mistake.
- ii) The costs of travel and per diem costs, including travel days, of the UIPM MD are borne by UIPM. The costs of full board accommodation and local transportation are borne by the Organising Federation/LOC.

1.16.5 UIPM Business Affairs Delegates (BADs)

- i) For each Category "A" competition, the UIPM will appoint a UIPM Business Affairs Delegate (BAD) who will be responsible to monitor and enforce compliance LOCs, of pentathletes and team officials with their obligations under their Marketing Declarations.
- ii) The costs of travel and per diem, including travel days, of the UIPM BAD are borne by UIPM. The costs of full board accommodation and local transportation are borne by the Organising Federation/LOC.

1.16.6 Jury of Appeal

- i) At official UIPM Category "A" competitions, the Jury of Appeal consists of seven members. At all other official UIPM competitions, it consists of five members.
- ii) At Olympic Games, World Championships and World Cups, two of these members are TDs.
 - a) The third member of the Jury of Appeal is the representative of the LOC who must hold an International Judge's licence for the five Modern Pentathlon events.
 - b) Three further members must be members of the UIPM TC.
 - c) The seventh member of the Jury of Appeal must be a team representative holding an International Judge's licence for the five Modern Pentathlon events. This NFs' Representative is elected by the team representatives at the first TM taking place at the relevant competition.
 - d) Members of the UIPM TC may be substituted by persons holding an International Judges licence for the five Modern Pentathlon disciplines.
- iii) At official UIPM Category "B" competitions one of the five Jury members must be a UIPM TD/NTO and holds the chair. The Jury of Appeal further consists of one representative of the LOC who must hold an International Judge's licence for the five Modern Pentathlon events.
 - a) Two other members must be International Judges holding the licence for the five Modern Pentathlon events.

- b) The fifth member of the Jury of Appeal must be a team representative holding an International Judge's licence for the five MP disciplines. This NFs' Representative is elected by the team representatives at the first TM taking place at the relevant competition.
 - iv) The Jury of Appeal must not include an Event Director. It is recommended to appoint a reserve member, holding an International Judge's license for the 5 disciplines, in case of conflict as below in 1.16.7 v).
 - v) In matters in which a nation or a coach is concerned of which the chairperson or a member of the Jury of Appeal is a citizen or works for this nation, this member shall be considered ineligible and shall not have the right to vote or participate. If the chairperson is considered ineligible, the senior member by age of the Jury of Appeal shall take the chair. Discussion and voting will take place without the presence or participation of the ineligible person.
 - vi) Elections for the Jury are made by show of hands at the first TM, with one vote per NF.
 - vii) The Jury of Appeal meets to decide on appeals and protests and also on request of the Pentathlon Director or UIPM TD/NTO to decide on controversial legal issues raised during the course of a UIPM event. In cases, unforeseen by the UIPM Rules or in exceptional circumstances, it is the duty of the Jury of Appeal to make a decision in a sporting spirit with due respect to the intention, aims and purposes of the UIPM Rules.
 - viii) The Jury of Appeal meets immediately after the end of the Laser Run competition and makes its decision before the awards ceremony. In cases of potential disqualification, disciplinary punishment or disciplinary measures, the Pentathlon Director, and in all other cases the relevant Event Director, must set out the reasons for the decision protested or appealed against. The person affected concerned must be given the opportunity of a legal hearing and access to the services of an advisor.
 - ix) The Jury of Appeal's decision is taken by secret ballot without the presence of the person involved or his advisor. A majority vote is acceptable. If there is any doubt the Jury must decide in favour of the person liable to disqualification, disciplinary punishment or a disciplinary measure. In case of an equal number of votes, the President of the Jury of Appeal has a further deciding vote. The terms of the decision and brief reasons are to be put in writing and kept at the premises of the UIPM. Any appeal or protest will be rejected in case of the unjustified non-appearance of the person concerned.
 - x) The Jury of Appeal is not restricted in the admission or evaluation of evidence. Its decisions are final.
- i) The constitution, responsibilities and obligations of the LOC must follow the bidding forms as submitted under Article 1.8 and declarations under Article 1.9.
- ii) The LOC must appoint:
- a) A Pentathlon Director, holding the IJ licence for the five disciplines, and having the authority to act as member of the Jury of Appeal, acting as liaison on behalf of the LOC with the UIPM TDs and who is responsible for the application of the UIPM Rules at the competition under the supervision of the UIPM TDs.
 - c) Qualified National Technical Officials and sports specialist volunteers to take on the duties and responsibilities of all the Discipline Authorities listed in the UIPM Competition Rules.
 - d) LOC members and volunteers to manage the requirements of successfully staging a UIPM event according to the Bidding documentation, Declaration of Duties, UIPM Rules, Statutes and Guidelines in force at the time of the competition.
- iii) The LOC is responsible to provide all the equipment and event logistics as listed in UIPM Rules, Regulations and Guidelines in force at the time of the competition.

1.16.7**Local Organising Committee (LOC)**

1.16.8 Technical Meeting

- iv) The LOC must immediately send the final results of the competition in the appropriate format as indicated by UIPM to the Technical Committee Chair and to UIPM HQ.
- i) The Technical Meeting (TM) is a part of the competition and is held before the first event of the competition. There must be a separate TM per gender taking place the day before each gender competition. Attendance of the coaches or representatives of all participating teams is compulsory. Each team is entitled to be represented by a maximum of two members. A team unable to be present at the TM must inform the LOC at least 24 hours in advance with the necessary data (name of the pentathlete, Licence ID number, results in swimming, start position in team, etc.) and delegate another nation or official to represent them. Teams not represented at the TM will not be allowed to start the competition.
- ii) At the TM, roll call of the participants takes place and the Event Directors are introduced to the teams. Instructions concerning the competition must be given and elections for the Jury of Appeal take place. The following information must be distributed:
 - a) The programme, including transport and meals
 - b) The Medical Plan
 - c) The riding course plan
 - d) Details of the Laser Run Course
 - e) The composition of the groups and the start list in Fencing and Swimming for the Qualifications (which shall be prepared after the roll call)
 - f) Equipment Controls information
 - g) The list of horses with their characteristics (including the use of whip and spurs) and results of the "Jumping test", at the latest distributed a minimum one hour before the start of the draw for horses
 - h) For the Semi-finals and Finals, the start lists including minimum of 3 reserves

1.17 START LIST AND START ORDER

1.17.1 Athletes Order inside the Team in the Relay

- i) The start order for the different events in the Relay must be declared in writing by the team representative for each participating team member before the TM and, once approved by the UIPM TD, cannot be changed. It is not possible to substitute the registered pentathletes after the TM, except in case of force majeure, which shall be determined by the decision of the UIPM TD.
- ii) For the Mixed Relay, Women compete first, then Men.

1.17.2 Publication of the Start Lists

The LOC must publish the start lists for the fencing and swimming in Qualification events at the TM. Prior to the start of the riding event all participating NFs must be provided with the start list for riding by the LOC. The start list for the Laser Run must be available five (5) minutes after the end of the previous discipline. Media, VIP and the public must also receive the start lists via application and/or on the large display scoreboard on site.

- i) If an athlete has DNF or DNS in the previous discipline they may take part in the following discipline. An athlete/team has to confirm immediately, but at latest 10 minutes before the start of the next event their participation. The athlete's name remains published on the start list with the remark 'DNS' in case of non- participation.

1.18 COMPETITION RESULTS

1.18.1 Modern Pentathlon Points

Modern Pentathlon (MP) Points are awarded according to the pentathletes' performances in each discipline.

1.18.2 Displaying the Results

- i) Immediately after the end of the competition in each event, the Event Director must present the results received from the results team to the Technical Delegate, who must sign them before distribution, most preferably in digital format. The same procedure must be followed with the accumulated results after the already disputed disciplines and the start order for Swimming or Laser Run. If the competition also has a classification by teams, the team results outputs must also be signed and distributed.
- ii) At UIPM Category A competitions the results of the different disciplines and the accumulated results must be shown on a large display scoreboard during the events, and online results must also be distributed to the coaches and media at the end of each event. The same procedure applies to the Start Orders.
- iii) In Fencing Category A and B competitions, it is compulsory to produce round-by-round results of matches for the teams and spectators. The results of the rounds must be shown on the large display.
- iv) In Riding Category A competitions, the data and results of each rider must be shown on the large display scoreboard simultaneously with their progress on the riding course. After each Rider the accumulative results must be displayed at the scoreboard.
- v) In Laser Run Category A competitions, during the event, the scoreboard must show the development of the competition and the results in the shooting range.

1.18.3 Final Positions and Points

The first pentathlete/team to cross the finish line in the Laser Run phase is the winner. If the winner has fewer points in total score, then Modern Pentathlon points must be added to this pentathlete/team so that their pentathlon score is the same. A final result list of all pentathletes/teams is made at the end of a competition. Pentathletes/teams are ranked according to the place first and then the number of Modern Pentathlon points scored. This list must be distributed by the LOC to all participating NFs and UIPM Delegates before they leave.

1.18.4 Ties

- If there is a tie between two or more athletes after two, three or four phases, the athlete with the best result in the last phase will be ranked in the higher position. If the tie remains, the athlete with the best result in the previous phase will be ranked in the higher position, and so on. If the tie cannot be broken, the athlete with the higher Pentathlon World Ranking (PWR) will be ranked first.
- If athletes finish the Laser Run (running/shooting) phase in a tie (and placings cannot be determined by Photo Finish), the athlete with the best result in Laser Run (running/shooting) will be placed in the higher position. If the tie remains, the athlete with the best result in the immediately previous phase (Swimming), and so on (Fencing and Riding) will be placed in the higher position. If the tie remains, the athlete with the better Pentathlon World Ranking (PWR) position will be placed higher.
- This applies equally for ties in points after qualification to rank pentathletes across groups.

1.18.5 Team Classification in an Individual Competition

- i) At the end of the Individual competition, including results for the best 3 team members (if 4 athletes, only the best 3 count). The total number of points combined from a nation's highest 3 total scores determines the results of the team classification.
- ii) Only teams with minimum 3 athletes entered for the competition can be ranked for team classification
- iii) Teams with more athletes in the Final are ranked higher.
Teams with 3 athletes (or more) in the Final are ranked ahead of teams with 2.
Teams with 2 athletes in the Final are ranked ahead of teams with 1.
Teams with 1 athlete in the Final are ranked ahead of teams with zero.
The same logic will be applied to Semi-final results in case is needed.
- iv) For any athlete qualified for the Final, her/ his final result must be used.
- v) For any athlete qualified for the Semi-finals but not for the Final, her/his Semi-final result must be used.
- vi) For any athlete not qualified for the Semi-final, her/ his Qualification result counts.
- vii) In a Final among teams composed of the same number of athletes, the winner is the team with the highest score. If there is a tie, 1.18.4 applies. If it is impossible to break the tie, they will be declared equal.

1.18.6 Prizes and Awards

- i) At UIPM World Championships medals with ribbon provided by UIPM/LOC are as follows: a gold medal is awarded for the first placed pentathlete in the Individual and for each team member of the first placed team, and in the Relay. A silver medal is awarded for the second place, and a bronze medal awarded for third place.
- ii) The same applies for the Individual competition winners at the UIPM World Cup Final where prize money is also awarded.

PART E**REGISTRATION OF THE PERFORMANCES****1.19
PENTATHLON
WORLD RANKING
(PWR) LISTS****1.19.1****Official List**

- i) The PWR is the official list used to rank pentathletes. It includes the ranking points awarded to the pentathletes according to their three best placing in the official UIPM international competitions with at least three nations and 12 athletes (correctly registered and currently licenced with UIPM) held during the preceding 12 months. If during this 12 months period there are 2 competitions of the same type, such as Championships or Series Finals (example: 2 CCh, 2 WCh, 2 WCF) only the most recent will be included in the PWR. For Junior and U19 rankings the highest of respective age group, during the past 12 months counts.
- ii) Every pentathlete earns PWR Points according to the level of the competition and his final place as specified in the PWR Point Table, in Appendix 1 below. Only pentathletes that have completed the competition will earn PWR points.
- iii) There are PWR individual lists for Senior, Junior and Youth, for both genders, updated in the UIPM website after each competition and the official confirmation of the results by the TD/NTO. The PWR lists are identified by the age group, gender and date. Only competitions comprising Fencing, Swimming and Laser Run count towards Youth Olympic PWR.
- iv) Junior and Youth athletes are included in the corresponding age group PWR list and in the upper PWR lists if they compete in those age group competitions. Junior athletes competing in Senior competitions will receive their Senior PWR points in the Junior PWR. Youth athletes competing in Senior or Junior competitions will receive their Senior/Junior PWR points in the Youth PWR.
- v) If the number of Senior or Junior Relay competitions is greater than 3 during a year, Mixed Team Relay PWR by nation and Team Relay PWR by nation, must also be published.
- vi) Separate PWR Lists will be established for Olympic and Youth Olympic Rankings.

1.19.2**Levels of UIPM
Competitions**

- i) For the purpose of establishing the PWR, the UIPM competitions are divided into four levels:
 - Level 1:** Olympic Games, World Championships, World Cup Final
 - Level 2:** Continental Championships/Games, World Cup Competitions, CISM World Championships that meet the criteria for level 2
 - Level 3:** Regional Championships/Games and International World Ranking Competitions that meet the criteria for level 3 Continental Championships, World Cup Competitions, CISM World Championships that do not meet the criteria for level 2
 - Level 4:** Continental Championships, World Cup Competitions, CISM World Championships, Regional Championships and International World Ranking Competitions which do not meet the criteria for level 3.
- ii) Criteria to Determine the Competition Levels 2-4

	Level 2									Level 3						Level 4					
	Europe			Other Conti.			Europe			Other Conti.			Europe			Other Conti.					
	Nat.	A.	%	Nat.	A.	%	Nat.	A.	%	Nat.	A.	%	Nat.	A.	%	Nat.	A.	%			
Men	10	32	30%	8	26	15%	8	24	20%	6	20	10%	6	18	5%	4	16	0%			
Women	8	30	30%	6	20	15%	6	20	20%	4	16	10%	4	16	5%	3	12	0%			

1.19.3 Tie-Breaker Applied to PWR

NAT = Number of Nations: Only nations present at the competition that had minimum one pentathlete competing in all 5 events

A = Number of Pentathletes: Only pentathletes that completed **all five disciplines** in Senior and Junior Semi-finals and Finals or all four disciplines in Qualifications and Youth are taken into consideration. DNF and EL are valid results. **DNS** and **DSQ** are **not counted** Athletes must have achieved minimum results of
Senior: 875 points men, 800 points women
Junior: 700 points men, 575 points women

'%' means the percentage (%) of pentathletes in the top 100 of the current PWR list

- i) In the PWR list, if two or more pentathletes have accumulated an equal amount of PWR points, the pentathlete who is placed higher is the one who achieved the highest place in his/her 3 included competitions.
- ii) If the amount of PWR still remains equal, the pentathlete who collected the most PWR points in his/her most recent competition takes the higher position.
- iii) If the amount of PWR still remains equal, the pentathlete placed higher is the one who collected more PWR points in the most recent World Championships

1.19.4 World Cup Standing

- i) The World Cup Standing List is published after each World Cup and is established by using the PWR points from the three best results on the annual World Cup Series. All competitors at each World Cup competition will be allocated points according to the placing.
- ii) The points table for the World Cup is the same as for the PWR.
- iii) For the World Cup Final, qualification of the best 33 (or 32) pentathletes is calculated adding the three best results of the World Cup competitions. In case of less than three results, the pentathlete is placed according to the total number of points over one or two competitions. In case of equal points Article 1.19.3 applies, whereby instead of an event a World Cup competition counts. The last World Champion, or in the Olympic Year also the Olympic Champion, and two pentathletes from the organising country, if not qualified otherwise, take the last positions. If a pentathlete does not participate in the World Cup Final he will be substituted by the next pentathlete in the World Cup Standing list.
- iv) The pentathlete that crossed the finish line first in the World Cup Final is awarded the title "Winner of the Modern Pentathlon World Cup Series".
- v) The final classification for the World Cup is made according to the results of the World Cup Final.
- vi) If there is a tie in the points, the athlete who is placed higher is the one who achieved the highest place in their included World Cup competitions. If there is still a tie, the athlete who placed higher in the most recent World Cup competition is placed higher. If there is still a tie, the athlete that took part in the most World Cup events is placed higher in the results list.

1.20 MODERN PENTATHLON WORLD RECORDS

Modern Pentathlon World Records may only be achieved in category A competitions for each gender and category (Senior, Junior, Under 19). World Records can only be validated if no penalties to the pentathlete in the respective event have been applied.

- i) There will be records for Individual, Team Relay by 2 athletes the same gender, Mixed Team Relay by 2 athletes from the same nation.
- ii) The different records are:

Fencing – The highest Pentathlon Points and the amount of victories and defeats only in fencing ranking round competition of 36 athletes in the Semi-finals. Points achieved in the Fencing Bonus Round either in the Semi-final or Final are included.

Swimming – The fastest time and the corresponding Pentathlon Points over 200m for 25m pool and 50m pool

Laser Run – The fastest time on any course and the corresponding Pentathlon points.

Overall Points – The most Pentathlon points overall in a competition.

- iii) Relay World records are established only when there is a minimum of 16 teams in same gender relay and maximum 24 teams in Mix Relay competitions.
- iv) Continental Bests and Personal Bests may be recorded for statistical purposes.

PART F

SAFETY AND DISCIPLINE

1.21 SAFETY

1.21.1

Responsibility of Pentathletes

Pentathletes arm, equip and clothe themselves and compete at their own responsibility and at their own risk, but on the condition that they must observe all the rules of each discipline. In Riding, pentathletes are not allowed to compete if the National Federation has not certified in writing to UIPM the riding ability of the pentathlete or provided permission (e.g. through the International Licence).

1.21.2

Safety Measures and LOC Responsibilities

The safety measures and standards specified in the Rules are designed to increase the pentathletes' safety but cannot guarantee it. They cannot, therefore, whatever the manner in which they are applied, give rise to responsibility on the part of the UIPM, or the organisers of competitions, or to officials and personnel who assist in such organisation, or anyone who may cause an accident.

1.21.3 Equipment

All pentathletes taking part in competitions must use equipment which complies with the requirements set out in these Rules, Technical Equipment Regulations and other guidelines established by UIPM.

1.21.4 Behaviour

All persons taking part or attending the different events must act in appropriate and orderly manner. During the competition, no person is allowed to approach the FOP, to advise the pentathletes, to criticise or insult the referees or other officials, to applaud before the Referee's decision or to hinder the organisation or presentation of the event in any other way. The Referee may, if it is possible immediately stop any act that disturbs the smooth running of the competition.

1.21.5

Entrance in the FOP

Only the following persons are allowed to enter the Event Area:

- i) The UIPM President and a member of the Executive Board;
- ii) The UIPM Technical Delegates/National Technical Observers;
- iii) The UIPM Medical Supervisors;
- iv) The members of the Jury of Appeal;
- v) The pentathletes in their official national uniform, each of whom being allowed to be accompanied by a member of their team, also in their official national uniform;
- vi) The nominated Referees and auxiliaries and persons specifically accredited by the LOC.

1.21.6

Restricted Entrance

If there is a Restricted Fenced Area within the Event Area (e.g. marked by boards) or an area specifically designated as a Zone for Coaches, only the pentathletes, coaches, referees, ground judges, timekeepers, scorers and the UIPM TDs/NTOs all of them in their own official national uniform may be present in this area. All other persons must stay outside in the areas assigned to them by the Organising Committee.

1.21.7

Zones for Coaches (ZFC)

- i) The Organising Committee may set up a ZFC or ZFCs, clearly marked as such, for any discipline adjacent to the FOP, and in the tribune.
- ii) All coaches in the ZFC must wear national uniform according to Article 1.22.2:
- iii) The number of coaches from any NF within a ZFC must not exceed the number pentathletes from that NF competing in the discipline in question.

1.22 OBLIGATIONS of Athletes, Officials, NFs and their Members, LOCs and LOC Members

1.22.1 Declarations

Pentathletes as well as team officials and members of the LOC of a UIPM competition are obliged to follow the UIPM Statutes and UIPM Rules and to respect the principles of fair play. Pentathletes as well as team officials are obliged to sign a UIPM Declaration of Obligations for Pentathletes and Team Officials and a Declaration concerning the Acceptance of the UIPM Court of Arbitration, both provided for by the UIPM HQ. Pentathletes and team officials receiving equipment within UIPM sponsor programs free of charge are obliged to sign a Marketing Declaration.

1.22.2 Clothing

- i) Pentathletes must wear clothing and equipment as specified in the Rules for each event.
- ii) Officials must be dressed properly, at a minimum by the National Federation's tracksuit.
- iii) No pentathlete is allowed to compete with dirty clothing or with a mark, flag, emblem, country or city name that belongs to a NF other than the NF of the pentathlete.
- iv) Pentathletes or officials dressed incorrectly are liable to a penalty or disciplinary measures.
- v) NFs shall submit details, including a picture, of their kit (National Uniform) for the forthcoming year to the UIPM before the first World Cup in each year and commit to use their team uniform (for athletes and coaches) accordingly throughout the FOP and in any Zone for Coaches.

1.22.3

Equipment and Equipment Control

- i) The LOC must inform team officials and pentathletes at the Accreditation Centre where and when they will have their equipment inspected.
- ii) Pentathletes are obliged to present themselves at the Equipment Control Checking Centre, at the time advised in the timetable of each UIPM official competition, with the equipment they intend to use during the event referred to.
- iii) The number of articles handed to the Equipment Control Checking Centre is limited to four weapons, three body wires and two masks and one glove per pentathlete in Fencing, two pistols in Laser Run and one headgear in Riding. Each nation must submit its equipment in a bag at the Centre.
- iv) The checked equipment, signed with a distinctive mark, will be handed over to the team captains a minimum one hour before the beginning of the event and in one-day competitions before the beginning of the first event.
- v) A final check is made in each event according to the rules in the corresponding chapter. Pentathletes will not be allowed to start the event if their equipment does not have the check mark. Pentathletes and teams without complying equipment are liable to be penalized.

1.22.4

Start Numbers

The start numbers, indicating the start order for the Riding, Fencing, and Laser Run, are provided by the LOC in accordance with UIPM Visual Guidelines and must be worn by the athletes.

1.22.5 Anti-Doping

Pentathletes have to accept and undergo doping controls according to the UIPM Anti-Doping Rules and Procedures.

1.22.6 Insurance

All NFs must ensure that their pentathletes and officials are adequately insured against all relevant risks including any accident or illness during any competition organised under the UIPM Rules. The LOC, and the UIPM disclaim any liability, financial or otherwise, for any injury, physical damage or illness suffered by any member of a delegation entered for a UIPM competition.

1.22.7

Smoking is forbidden at all competition sites.

1.23 DISCIPLINE

Everybody participating at the different events must remain orderly and must not disturb the smooth running of the competitions. Pentathletes must demonstrate good behaviour and respect the authorities' orders and decisions during the entire event, warm-up periods included. They must observe the regulations and the decisions of the Referees, be respectful towards the Event Directors and the members of Juries and obey the orders, requirements and injunctions of Referees and judges. Any breach of this rule will be liable to proceedings according to the UIPM Rules.

1.23.1 Disciplinary Actions

Penalties and Punishments are applied to pentathletes. Disciplinary measures are applied according to the UIPM Code of Ethics.

1.23.2 Penalties for Athletes

Violations of the rules of any event by pentathletes, as laid down by the UIPM Competition Rules, are sanctioned by **penalties**. The rules for each event define the elements of the offences and the type of penalty to be imposed.

- i) Penalties are applied by referees, who immediately notify the athlete and/or the coach and who must register the nature of the violation and the penalty.
- ii) Penalties that may be imposed are a start prohibition, warnings, time and point penalties and elimination.

1.23.3 Punishments for Athletes

- i) Violations of the principles of fair play and unsporting conduct as well as offences against the UIPM Statutes, the UIPM Code of Ethics, and all UIPM Rules and Resolutions by pentathletes are liable to be sanctioned by disciplinary punishments. The UIPM Code of Ethics define the elements of the offences and prerequisites for disciplinary punishments as well as the types that are imposed.

1.23.4 Disciplinary Measures - Other Persons

- i) Violations of the principles of fair play and unsporting conduct, offences against the UIPM Statutes, the UIPM Code of Ethics or any other UIPM Rules or the resolutions of organs of the UIPM by coaches, trainers, officials and staff of the UIPM and its members, individual members of the UIPM and members of the UIPM Committees and spectators are sanctioned by disciplinary measures.

1.23.5

For **Sanctions on NFs and LOCs** see UIPM Statutes, Rules on the Internal Organisation and UIPM Code of Ethics .

1.23.6 Decisions on Penalties

Decisions on penalties by the competent authorities according to the Rules for the relevant event that are not the subject of a verbal complaint at the time or any protest at the time or immediately thereafter are final. In these cases no legal hearing takes place. Where a penalty is imposed, the competent authority will immediately notify the pentathlete or the representative of his team or other person concerned the fact and terms of the penalty and officially register the type of and reason for the penalty.

1.23.7 Elimination and Disqualification

- i) **Elimination (EL)**
Elimination is a penalty for a serious mistake concerning the rules of the event that may not have been committed deliberately. A pentathlete eliminated from an event scores zero points in the relevant event, but is allowed to compete in the following events of the competition.
- ii) **Disqualification (DSQ)**
Disqualification is a penalty for deliberately attempting to circumvent or deliberately circumventing the rules of the event. A pentathlete disqualified in a UIPM event will not compete in any of the subsequent events in that competition.
- iii) **Disqualification for unsportsmanlike Behaviour (DQB)**
For serious cases of unsportsmanlike behaviour, the pentathlete can receive DQB. In this case the pentathlete will not compete in any of the subsequent events in that competition, neither in any competition of the championships. Further sanctions may be applied.

1.23.8 Verbal Complaints

- i) Any decision taken by a Referee on a point of fact on the field of play is final and can not be complained or protested against.
- ii) A pentathlete or another person concerned believing the competent authority's decision to be incorrect, may ask for an explanation of the decision from the authority making the decision. If the explanation is not satisfactory, he may carry the matter, politely and without formality, to the

1.23.9 Protests

relevant Event Discipline Director by a verbal complaint. A verbal complaint is an oral expression of dissatisfaction, made by a pentathlete or team official, concerning an action done by a competition official.

- i) The decision on a verbal complaint is subject to a protest to the Jury of Appeal. A protest is an expression of dissatisfaction with a decision taken by the competition official. All protests must be filed in writing referring to the relevant Article, in English, and made within fifteen minutes of the decision in question.
- ii) A protest may be raised orally if it refers to an error in a result or to the breach of the UIPM Competition Rules in the preceding event which influences the starting place of a pentathlete in the next event. Such a protest must be submitted not later than 20 minutes prior to the start of the next event.
- iii) All protests must be accompanied by a deposit of 60 Euros or the equivalent sum in convertible currency. In case of a successful protest the sum is returned to the person who raised the protest, in case of unjustified protest the deposit becomes the property of the UIPM.

1.23.10 Interruptions Caused by Protests or Appeals

- i) If the protest does not oblige the checking of any of the equipment, the competition will continue without interruption.
- ii) Should the Jury of Appeal order a replay this will take place at the earliest possible opportunity.
- iii) If such a protest or appeal is deemed unjustified the athlete will be penalised.

**APPENDIX 1 – PWR
POINTS**

**PENTATHLON
WORLD RANKING
POINTS TABLE**

FINALISTS

Place	Competition levels			
	1	2	3	4
1	80	60	40	20
2	75	55	36	17
3	70	51	33	15
4	66	48	31	13
5	63	46	29	11
6	60	44	27	10
7	58	42	25	9
8	56	40	23	8
9	54	39	22	7
10	52	38	21	6
11	50	37	20	5
12	48	36	19	4
13	46	35	18	3
14	44	34	17	2
15	42	33	16	1
16	40	32	15	1
17	39	31	14	1
18	38	30	13	1
19	33	25	9	1
20	32	24	8	1
21	31	23	7	1
22	30	22	6	1
23	29	21	5	1
24	28	20	4	1
25	27	19	3	1
26	26	18	2	1
27	25	17	1	1
28	24	16	1	1
29	23	15	1	1
30	22	14	1	1
31	21	13	1	1
32	20	12	1	1
33	19	11	1	1
34	18	10	1	1
35	17	9	1	1
36	16	8	1	1
37	15	7	1	1
38	14	6	1	1
39	13	5	1	1
40	12	4	1	1
41/42/43...	11/10/9...	3/2/1/.....	1/1/1....	1/1/1...



RIDING

PART A

THE EVENT

2.1 PRESENTATION OF THE EVENT

- 1 Type and Speed
- 2 The Course

- 3 Fields of Play - The Arenas
- 4 Provision of Horses

2.2 AUTHORITIES

- 1 Riding Director
- 2 Referee
- 3 Secretary
- 4 Timekeepers
- 5 Announcer
- 6 Course Builder
- 7 Course Builder Assistants

- 8 Starter
- 9 Warm-up Judge
- 10 Horse Distribution Judge
- 11 Equipment Judge
- 12 The Veterinarian
- 13 Additional Veterinarian
- 14 Riding Steward

2.3 ORGANISATION AND SCHEDULE OF THE EVENT

- 1 Building the Course
- 2 Jumping Test
- 3 Official Course
- 4 Inspecting the Course on Foot
- 5 Horse Selection
- 6 The Draw
- 7 Conduct of the Draw

- 8 Start Order Preparation
- 9 Organisation of Horse Groups for Relay
- 10 Accompanying Drawn Horses
- 11 Confirmation of a Horse's Ability
- 12 Scheduled Start Time
- 13 Re-schooling Horses

2.4 CONDUCT OF THE COMPETITION

- 1 Treatment of Horses
- 2 Mounting and Warm-up
- 3 Entering the Arena on Foot
- 4 Entering the Competition Arena
- 5 Communication with the Pentathlete
- 6 Saluting
- 7 The Start
- 8 Execution of the Course

- 9 Unauthorised Assistance
- 10 Assistance inside the Competition Arena
- 11 Lost Headgear when Mounted
- 12 Exiting the Arena
- 13 Knock-down
- 14 Knock-down after Crossing the Finish Line
- 15 Disobediences

**2.5
SCORING POINTS**

**2.6
INFRINGEMENTS
AND PENALTIES**

- 16 Exceptions to Disobedience
- 17 Refusal
- 18 Run-out
- 19 Resistance
- 20 Faults in Combinations
- 21 Particular Fault Situations
- 22 Falls

- 1 The Score

- 1 Types of Penalties
- 2 Time Penalties
- 3 Incorrect Dress Penalties
- 4 Obstacle Penalties

- 23 Timing
- 24 Timekeeping
- 25 Time Allowed
- 26 Time Interruptions
- 27 Time Limit
- 28 Transition in Relay Competitions
- 29 Safety

- 2 Positions

- 3 Particular Relay Penalties
- 4 Other 10 Points Penalties
- 5 Elimination
- 6 Disqualification

PART D

ANNEXES

Appendix 2A

PENALTY TABLES

Appendix 2B

TIME POINTS TABLES



2

RIDING

PART A

THE EVENT

2.1 PRESENTATION OF THE EVENT

2.1.1 Type and Speed

The Riding event is a show jumping event, with a penalty table specific to modern pentathlon, organised both for Individuals and for Relays at a target speed of 350 m/minute in an arena maximum 2500 square metres.

2.1.2 The Course and Riding Course Plan

- i) At Individual competitions on a riding course of 350-400m length consisting of 10 obstacles, two combinations of two elements (double) must be included. A minimum of 5 elements in senior, and 2 elements in junior riding competitions must be set at the maximum height relevant to the status of the competition. The height of the course obstacles must be made in accordance with the standard of the horses.
- ii) In Category A Relay competitions, the course consists of 8 obstacles without a combination on a 2 x 260-300m course.
- iii) The LOC must provide the riding course plan. This plan must include:
 - the positions of the start and finish lines;
 - the relative positions of all obstacles and their dimensions, their type and order;
 - any compulsory turning points;
 - the length of the course as it was measured;
 - the track marked either by a continuous line to be followed precisely by the pentathletes or by a series of arrows showing the direction in which each obstacle must be jumped, then the track to be chosen freely by the pentathlete. Should there be a compulsory section in an otherwise unrestricted course, both methods must be used on the same plan;
 - the time allowed and the time limit;
 - the judges' box.

2.1.3 Fields of Play - Arenas

- i) The LOC must provide an enclosed warm-up arena for jumping with one upright and one spread obstacle duly lineated by red and white flags and another separate area for flatwork without jumps. The warm up arena for jumping must be a minimum of 30m x 40m (maximum 6 horses).
- ii) The two warm up obstacles in the warm-up arena must be jumped in the same direction.
- iii) A big digital clock, must be in the mounting area and visible by the pentathletes and coaches also from the warm-up arena. If the competition arena is at more than 200 metres from the warm-up arena, in the entrance there must be another clock.
- iv) The competition arena must be enclosed and be a maximum of 2500 m² (e.g 50m x 50m). The height of the borders must be a minimum of 1m. Whilst a horse is in the competition arena during a competition, all entrances and exits must be closed.
- v) In individual competitions the start line must not be more than 15m nor less than 6m from the first obstacle. In relay competitions the start line

- must be not more than 30m nor less than 10m from the first obstacle. The finish line, for individual and relay competitions must not be less than 6m nor more than 15m from the last obstacle. Each of these 2 lines must be marked with an entirely red flag on the right and entirely white flag on the left.
- vi) For the Relay Competition, behind the start line a zone for changeover will be marked for about 20m in length and 10m width (minimum) where the Relay team is placed, awaiting the start. The changeover zone is an inseparable and integrated part of the competition arena. It must be clearly marked. The Exit of this zone is the Start line; the Entrance is the Finish line.
 - i) In Individual and team competitions, one horse is provided by the LOC for one pentathlete. In all cases the LOC must also provide one reserve horse for each five pentathletes starting in the last round.
 - ii) At all official UIPM Category "A" competitions the same number of horses as the number of athletes in each of the riding rounds must be provided by the LOC.
 - iii) If in a Category "C" competition one horse is provided for four pentathletes, the event, individual or team, must be organised on two consecutive days in two rounds per day.

2.1.4 Provision of Horses

2.2 AUTHORITIES

At all official UIPM competitions the following officials must be appointed: Riding Director, Deputy Director, Referee, Secretary, Timekeepers, Course Builder, Course Builder Assistants, Start and Finish Judge, Warm-up Judge, Judge for the Horses Distribution, Judge for the Equipment, the Veterinary Adviser ("the Veterinarian"), and Auxiliary people. An Announcer must also be appointed, but is not a member of the Jury. The UIPM also can appoint a Riding Steward for the major UIPM competitions.

2.2.1 The Riding Director, or his Deputy who must be qualified to replace him, has overall authority of the riding event and is responsible for:

- i) managing and coordinating the activities of all officials appointed;
- ii) supervising the building of the course and of the warm-up arena;
- iii) ensuring a sufficient number of horses for the "Jumping Test" and the competitions;
- iv) in cooperation with the UIPM TD/NTO selecting the horses suitable for the events;
- v) requesting the certificate of the Veterinarian that the horses are fit to participate in the event;
- vi) ensuring the draw and preparation of the horses;
- vii) preparing and directing the work of the Announcer so the public is continuously informed on the event and the whole Modern Pentathlon competition.

2.2.2 The Referee is tasked to assess the achieved results accurately. He is responsible for:

- i) allowing the pentathletes on the course in accordance with time schedule;
- ii) giving the signal by using a bell to start, interrupt and resume the event or, eventually, if the pentathlete is not able safely to complete the course, to bring it to a premature end;
- iii) verbally evaluating the achieved results and faults of a pentathlete on the individual obstacles, during the jumping test and the ride on the course, including the faults during interruption of the event and assessing the final result of the pentathlete;
- iv) any additional drawing of lots for reserve horses and ensuring that the system of re-schooling horses is functioning.

2.2.3 The Secretary takes care of the paperwork in the Jumping Test and during the event and is responsible for:

- i) preparing the necessary requisites for drawing lots;
- ii) recording the number and name of each drawn horse;
- iii) issuing a note to the pentathletes with the number and name of each drawn horse and the mounting and start times for each respective pentathlete;
- iv) during the event, recording the oral commentary of the Referee in the event protocol;
- v) recording the time achieved by each pentathlete according to the information from the Timekeepers;
- vi) compiling the final points evaluation of each pentathlete.



**2.2.4
The Timekeepers are responsible for:**

- i) measuring every 30-second period after the signal for the start of a pentathlete and the 20 second period to resume the course after an interruption to rebuild an obstacle;
- ii) stopping and starting timekeeping in accordance with the advice of the Referee;
- iii) measuring the time of the pentathletes by stopwatch in case no electronic timekeeping system is available.
- iv) recording the times reached by each pentathlete.

**2.2.5
The Announcer informs pentathletes, teams and spectators on progress in the event and is responsible for:**

- i) announcing the pentathletes' names, the number and name of each drawn horse and calling for presentation of the horses;
- ii) presenting each pentathlete and horse before the start of the event;
- iii) after each pentathlete finishes the event, announcing time, deduction of points and the result of the pentathlete in the riding event as well as total points and placing in the light of the preceding events.

**2.2.6
The Course Builder prepares the course before the event and maintains the course during the event and is responsible for:**

- i) building the course for the event in compliance with these Rules;
- ii) completing inspection of the course with the UIPM TD/NTO and making amendments in accordance with instructions of the TD/NTO;
- iii) announcing by use of a visible red sign the knock-down of an obstacle or flags or other faults on the course;
- iv) carrying out the correct repositioning of the knocked-down obstacles or flags;
- v) announcing by use of a visible sign (drop down the red flag) that the course is O.K. and that the Referee may give a signal for resuming the competition.

2.2.7 The Course Builder Assistants are present on the arena during the competition and carry out all instructions of the Course Builder.

2.2.8 The Starter has the obligation of announcing that the pentathlete may start the ride by hoisting or waving a flag. Waving the flag announces that the pentathlete has passed the start/finish line. In the Relay competition, the starter checks the start of the 2nd pentathlete and announces any false start.

**2.2.9
The Warm-up Judge is responsible for:**

- i) recording the number of finished jumps;
- ii) making a pentathlete aware when he has reached the last permitted jump;
- iii) informing the Riding Director and Referee of any faults committed by the pentathlete or by a member of his entourage on the warm-up arena;
- iv) warning the pentathlete sufficient time in advance of their obligation to go to the entrance to the competition arena;
- v) in Relay competitions, collecting the start order from the team leader at a minimum 4 minutes before the relevant warm up time is finished.
- vi) in agreement with the Technical Delegate, forbidding a pentathlete, for safety reasons, to continue the riding event.

**2.2.10
Horse Distribution Judges are responsible:**

- i) to check that the horse equipment and saddles are prepared for the event;
- ii) that the pentathletes receive the appropriate drawn horse;
- iii) to hand the appropriate drawn horse to the pentathlete in accordance with the time space schedule and give the order to mount.

2.2.11 The Equipment Judge is located at the warm-up area(s) and is responsible for checking any whip, spurs and hat of the pentathletes before they enter the warm-up arena.

**2.2.12
The Veterinarian must:**

- i) present a written statement before the draw that all the horses are fit to participate;
- ii) assist at the drawing procedure;
- iii) be available during the competition in the warm-up area ready to check that no injured horses or/and horses affected by exposition to chronic stress are entering the competition;
- iv) immediately inform the UIPM TD/NTO in case of any horse injury;
- v) be ready to immediately attend the competition arena when requested;

2.2.13

In case the warm-up and competition arenas are not adjacent, the assignment of more than one veterinary shall be considered by the competition organizing committee.

2.2.14

The UIPM can appoint a Riding Steward for the main UIPM competitions, who have the following responsibilities, always in cooperation with the Technical Delegates, Riding Director and the Veterinarian:

- i) Supervising horse selection before and after the Jumping Test, course design, facilities and overall management preparations for the riding event.
- ii) Making every effort, that all horses presented and selected fulfil competition standards and requirements according to the UIPM Competition Rules and Modern Pentathlon standards, such as suitable to be ridden by unfamiliar riders.
- iii) Assuring the course is designed in compliance with the competition rules to allow for fair competition and proper test of the riding skills.
- iv) Guaranteeing that animal welfare is respected in terms of workload during the competition period.
- v) Flagging infractions of competition rules linked to lack of riding knowledge and horse welfare.
- vi) Delivering 60-90 min workshop during the main UIPM events in the season, mandatory to at least one coach per attending nation.

2.3**ORGANISATION AND SCHEDULE****2.3.1****Building the Course**

- i) The LOC must appoint a course builder to design and build the course. At Olympic Games and World Championships the LOC must inform the UIPM about this appointment in advance. The course builder must plan and prepare the course adjusting the size of the obstacles to the quality of the horses and in such a way that capable pentathletes will benefit from their skill. The UIPM TD/NTO must inspect the preliminary course not later than 2 days before the Jumping test.
- ii) At all other official UIPM Category "A" competitions and at UIPM Category "B" competitions the UIPM TD/NTO must ensure that the conditions are observed by inspecting the course and the horses at the riding venue at least 1 day before the start of the riding event.
- iii) The course is the track in the arena, which each pentathlete must follow after crossing the start line up to the finish line. The length must be measured accurately to the nearest meter taking into account, particularly in the turns, the normal line to be followed by the horse. This measurement line must pass through the middle of each obstacle.
- iv) The start line must be located so as to encourage a timely start.

2.3.2**Jumping Test**

The official inspection of the horses takes place in the form of a "Jumping Test" at the competition riding arena. Horses must not start the Riding event without being previously inspected.

- i) At the Jumping Test all horses must have their start numbers painted with indelible paint on their fore left hooves. The same horse numbers, visible from the spectator stands, must be also attached to the bridle. These marks must remain on the horse throughout all riding events at any UIPM Competition.
- ii) At Olympic Games and World Championships the UIPM TDs must inspect the passports or blue books of all the horses that will be presented at the jumping test.
- iii) During the official inspection officials, coaches, trainers, pentathletes and spectators can be present but do not have any right to interfere with the inspection. The LOC must provide to the coaches a riding protocol sheet with horses' characteristics including the use of martingale, whip and spurs numbers and names of the horses.
- iv) The horse equipment in the jumping test must be of the same kind as that used in the competition, especially in relation to the martingale and mouth piece. Fixed martingales are forbidden in all cases.



2.3.3 Official Course

- i) Immediately after the inspection of the horses, the UIPM TDs/NTOs must re-inspect the course together with the Course Builder and the Riding Director, after which they may decide to change obstacles and/or the plan of the course.
- ii) Only after this procedure has been respected does the course become the Official course. Except in a case of force majeure, no change whatever may take place after this decision. The TDs/NTOs must check that the Course Builder or his assistants mark the height on all obstacles.
- iii) Should force majeure make it necessary to alter the plan of the course after it has been posted, team representatives must be advised of the alterations.

2.3.4 Inspecting the Course on Foot

- i) Pentathletes and team representatives are shown the course on foot before the competition. The course will be open for 45 minutes after the time of the inspection of the horses following the TD/NTO approval of the course.
- ii) In addition, pentathletes and team representatives are given at least 20 minutes to inspect the course at any time during the competition programme according to the organiser's schedule.

2.3.5 Horse Selection

The horses must be selected with utmost care in order to secure equality among them. They must all be capable of completing the course at least twice in a day, without disobedience and with few faults, if any, for time or over obstacles.

- i) English saddles for show jumping with safety stirrup leathers will be supplied by the LOC, one saddle for each horse. Pentathletes cannot use their own saddle, but may supply their own reins, stirrup leathers and stirrups. Other than these no more parts of the saddlery may be changed unless it is of inferior quality, which is for the UIPM TD/NTO and Riding Director to decide. In the interests of safety, stirrup leathers and irons may not be attached to the girth and the foot may not be attached to the stirrup in any way.
- ii) A martingale with ring is compulsory if it is so prescribed on the list of the horses. Otherwise the martingale is forbidden. Blinkers and hoods are prohibited.

2.3.6 The Draw

- i) The list of competition and reserve horses must be given to the pentathletes a minimum of 1 hour before the start of the draw of the horses. This list must include:
 - a) Horse's numbers, name, sex, age, colour, temperament and other characteristics, special task or equipment, martingale, the use of whip and spurs, etc.;
 - b) The results of the test of the horses (errors at each obstacle as well as times).
- ii) The UIPM TD/NTO checks that one number for each horse is placed in a container on a table in the front of the pentathletes and that the numbers are well shuffled after being placed in the container.
- iii) If more than one athlete withdraws from riding before the draw takes place, a new horse list will be drawn up and distributed. The TD together with the Riding Director will decide which horse will be removed from the competition list and placed with the reserves. The withdrawn athletes will not appear on the riding start list anymore.
- iv) Once the draw has taken place, there will be no other draw.

2.3.7 Conduct of the Draw

The pentathlete or team ranked N°1 after the Fencing Bonus Round will draw a horse ten (10) minutes before the start of the competition general warm-up. If it is a Relay competition one pentathlete draws on behalf of the team. On the basis of this single draw, all the horses (that have been previously numbered) will be automatically distributed to all the other pentathletes/teams. There must be different draws for the Semi-final group "A", group "B" and Finals. The results team must produce immediately an update output with the numbers of all horses to be used by the Announcer, with the athletes ordered according to the order of presentation of athletes and horses. This output must include the mounting time and the starting time and must be distributed to the coaches and judges.

2.3.8 Start Order Preparation

In all competitions the start order is the reverse of the rank after the Fencing Ranking Round. In both Semi-finals and Finals the riding event must be organised in 1 round.

2.3.9 Organisation of Horse Groups for Relay

For each different Relay competition, the horses are classified according to the average of their previous performances (Jumping Test, Individual Competitions, Relay Competitions). The TD and Pentathlon Director must disregard the "athletes' mistakes" – jumps in the wrong direction, falls, etc. – in order to "qualify" the horses. The horses are then, using this "quality" numeration, grouped as follows:

At an example for the Relay with 20 teams, in 2 rounds:

1st group: horses nr 1 and nr 20, 2nd
group: horses nr 2 and nr 19, 3rd
group: horses nr 3 and nr 18, 4th
group: horses nr 4 and nr 17, 5th
group: horses nr 5 and nr 16, 6th
group: horses nr 6 and nr 15, 7th
group: horses nr 7 and nr 14, 8th
group: horses nr 8 and nr 13, 9th
group: horses nr 9 and nr 12, 10th group: horses nr 10 and nr 11.

2.3.10 Accompanying Drawn Horses

Pentathletes are authorised to watch the drawn horse in the warming up arena at the beginning of the warm-up during the trotting session. The International Judges and the members of the Jury of Appeal will also observe the horses.

2.3.11 Confirmation of a Horse's Ability

Before mounting, a pentathlete may ask for an examination of their horse if they think it is not fit to start. After consultation with the Veterinarian, the UIPM TD/NTO may decide to permit a change of the horse.

- i) The pentathlete concerned will then draw a new horse from the reserve horses. After having mounted, no change is permitted, except a horse that had passed the examination proves to be lame when under the weight of the pentathlete having just mounted and just begun warm up. In this case the UIPM TD/NTO, after consultation with the Veterinarian, is the only person authorised to permit a change.
- ii) Once the warm-up has started and a horse becomes lame, the UIPM TD/NTO together with the Veterinarian must decide not to permit the pentathlete to enter the arena with the horse.

2.3.12 Scheduled Start Time

The LOC must prepare the schedule of the event with particular attention, especially if there is a direct TV broadcast, ensuring some reserve time for unexpected situations, but avoiding "dead" times.

- i) Once the event has started, its conditions must not be altered and the course and the obstacles must not be changed.
- ii) If it becomes necessary to interrupt the event, e.g. because of a storm or problems with light, it must subsequently be continued using the same course and obstacles and as far as possible under the same conditions and at the exact point where it was interrupted.
- iii) In the Individual competition the pentathletes start 1:45 intervals. The size of the warm-up arena must be enough to allow up to 12 athletes and horses simultaneously and split over the flat work and jump sub-areas together (not more than 6 horses in the jump sub-area).
- iv) In the Relay competition with 2 horses per team, the teams start at 3 minutes intervals.
- v) The LOC must prepare the schedule of Riding events minimum 30 minutes interval for resting of the horses between the different competition stages.



2.3.13 Re-schooling Horses

- i) If a rider has been eliminated for a fall (either of the rider and/or the horse) or if a horse made 3 refusals or run-outs, or resisted for more than 30 seconds, it can only be selected for the next competition stage (even in the same day) if it has been successfully checked by the veterinarian in cooperation with the Technical Delegate and, after approved, re-schooled over the obstacle(s) in question. The re-schooling will take place immediately after the riding competition is over.
- ii) In the system of re-schooling the re-schooled horse must be shown to be obedient at the obstacle(s) concerned. But if the horse has one refusal, it must not be accepted. The UIPM TD has the right to decide which horses may be re-schooled and which cannot be accepted for the following competition stage.

2.4 CONDUCT OF THE COMPETITION

2.4.1 Treatment of Horses

The welfare of the horse must be always paramount, never being subordinated to any other considerations. Pentathletes must treat the horses with care, fairly and without cruelty. A pentathlete committing any act of cruelty as regards a horse will be penalised.

2.4.2 Mounting and Warm-up

Pentathletes may mount 20 minutes before their start time in the warm-up arena after receiving permission from the Judges for the Horse Distribution. They must collect the horse, prepared and ready to be mounted, in a special horse distribution area organised by the LOC, where at least the first 3 horses to be mounted must be present.

- i) It is permitted to adjust saddlery and other accessories before mounting.
- ii) In Individual competitions each pentathlete has the right to take 5 jumps in the warm-up arena. The Warm-up Judge must warn every pentathlete when they have jumped 4 times. Should the pentathlete nevertheless jump more than the allowed times they will be penalised by 10 points for each infringement.
- iii) In Relay, each horse has the right to take 5 jumps in the warm-up arena. The team representative determines the preparation of the horses in the warm up arena and the number of jumps for each pentathlete.
- iv) A pentathlete jumping an obstacle in the wrong direction in the warm-up arena will be eliminated.
- v) A pentathlete may be helped by a member of their team to adjust the height of an exercise obstacle in the warm-up arena, but never over the maximum height. Nobody may hold any part of an obstacle while the pentathlete is jumping.
- vi) A pentathlete can be eliminated by the Technical Delegate or Riding Director with agreement of Technical Delegate if the pentathlete is unable to control the horse, shows dangerous riding or non-sufficient riding ability.

2.4.3 Entering the Arena on Foot

Entry into the arena is prohibited as long as a notice "Arena Closed" is placed at the entrances or conspicuously displayed in the middle of the arena. Permission to enter the arena is given by the Referee ringing the bell and by displaying a notice "Arena Open". No one must enter the arena on foot once the competition has started. If this happens the Referee must ring the bell to stop the competition and the time and must order such undesirable person out of the arena. After that the Referee must order resumption of the riding. A pentathlete entering the arena during the competition on foot will be penalised.

2.4.4 Entering the Competition Arena

A pentathlete must enter the competition arena immediately after the previous pentathlete has crossed the finish line. If a pentathlete does not enter upon call, the call is repeated twice at 30 seconds interval, after which the pentathlete or team will be penalised.

2.4.5 Communication with the Pentathlete

Pentathletes must be attentive to the bell which is used by the Referee, in a manner to be heard in all corners of the arena, to permit pentathletes to enter the arena for inspection of the course and for the competition, to stop the event, to continue the event after interruption, to indicate the replacement of an obstacle or elimination of a pentathlete. The elimination is indicated by prolonged and repeated ringing of the bell. Any pentathlete who does not obey the signal to stop or who after an interruption attempts to jump an obstacle without waiting for the bell, will be penalised. Athletes must also be attentive to the orders or information transmitted through the loud speaker.

2.4.6 Saluting

- i) The pentathlete enters the arena and must salute the Referee.
- ii) The bell is rung immediately after the rider enters the arena.
- iii) The pentathlete must pat the horse after finishing the course and before leaving the competition arena. If a pentathlete or team misses to pat the horse, will be penalised.

2.4.7 The Start

- i) The signal to start is given by using the bell. A start can be postponed, but it must not be made earlier than indicated. After hearing the bell, the pentathlete must cross the start line within the next 30 seconds, when the time of the course will start. But if a horse has not crossed the start line 30 seconds after the signal of the bell to start, the time of the round will be taken from that moment.
- ii) A pentathlete starting before the start signal or jumping the first obstacle without having crossed the start line will be eliminated.
- iii) The athlete records a DNS if he/she does not cross the start line and starts (or attempts) the course after the bell has rung.

2.4.8 Execution of the Course

Pentathletes must respect the concept of the Modern Pentathlon Riding event and pass between the flag(s), red on their right side and white on their left side at the start line, all obstacles and the finish line. Pentathletes must complete the whole course in compliance with the plan and must jump over each obstacle in the prescribed order. Pentathletes must cross the finish line mounted before leaving the arena: otherwise the pentathlete will be eliminated.

The Jury and the Technical Delegate acting together have the right to eliminate the pentathlete if he (and/or the horse) is unable to perform the course, is unable to control the horse, shows dangerous riding or non-sufficient riding ability.

The pentathlete must, after two consecutive disobediences at an obstacle, continue to the next obstacle or the finish line.

2.4.9 Unauthorised Assistance

Any physical intervention by a third person during the course of a round, whether solicited or not, with the aim of helping the mounted pentathlete or their horse, except being handed headgear and/or spectacles, is considered as an unauthorised assistance and will be penalised. Verbal guidance is not allowed and any person ingringing will be judged as a breach of UIPM Code of Ethics. No penalty will be imposed to the pentathlete in this case.

2.4.10 Assistance inside the Competition Arena

Only the Course Builder Assistants may provide assistance to a dismounted pentathlete. They may help the pentathlete to catch the horse and to mount the horse.

2.4.11 Lost Headgear when Mounted

If a pentathlete, for any reason, loses his protective headgear, the Referee must ring the bell and the pentathlete must stop. If they do not, they will be penalised. The clock will be stopped. The pentathlete is always obliged to put their lost headgear on properly (with chin strap firmly closed around the chin) before continuing. If the pentathlete does not do this, the Referee must ring the bell again and the pentathlete will be eliminated. Accepting the lost headgear by an official on the course is permitted. For safety reasons, the same applies in the warm up-arena, including penalties.

2.4.12 Exiting the Arena

Pentathletes are not permitted to exit from the arena dismounted. If they do, they will be penalised, except in case of an injured athlete or horse.

2.4.13 Knock-down

An obstacle is considered to have been **knocked down** through a mistake of the horse or pentathlete if:



- i) the whole or any part of it falls, even if the part which falls is arrested in its fall by any part of the obstacle;
- ii) at least one of its ends no longer rests on any part of its support;
- iii) any arrangement intended to maintain the stability of the obstacle and forming an integral part of its support falls.
- iv) If any part of an obstacle that has been knocked down is likely to impede a pentathlete in jumping another obstacle, the bell must be rung and the clock stopped while this part is picked up and the way is cleared.
- v) If a pentathlete correctly jumps an obstacle, which has been improperly rebuilt, they incur no penalty, but if they knock down this obstacle they will be penalised.
- vi) When an obstacle or a part of an obstacle consists of several pieces placed one above the other and positioned in the same vertical plane (upright obstacle), only the fall of the top part is penalised.
- vii) When an obstacle which requires only one effort consists of parts which are not positioned in the same vertical plane (spread obstacle), the fall of one or several top parts only counts as one fault, whatever the number and position of the parts which have fallen. A top part of an obstacle includes any walls, trees, hedges, etc., which do not have a horizontal pole placed vertically above them.

2.4.14 Knock-down after Crossing the Finish Line

If any obstacle on the course, which has been struck by the horse or by the pentathlete when jumping it, reaches the ground after the finish line has been crossed, the pentathlete is not penalised. But if this obstacle (single or a combination) is the last on the course and it starts to fall before the pentathlete has crossed the finish line, it counts as a fault even if the obstacle reaches the ground after the finish line has been crossed. However, it does not count as a fault when the obstacle reaches the ground after the pentathlete has left the arena.

2.4.15 Disobediences

The following are considered as **disobedience** and are penalised as such:

- i) Refusal;
- ii) Run-out;
- iii) Resistance;
- iv) More or less regularly circling, no matter when this occurs on the course or for whatever reason;
- v) Crossing back over the track between the last obstacle jumped and the next obstacle on the course, unless allowed on the plan of the course.

2.4.16 Exceptions to Disobedience:

The following are considered as exceptions to disobedience:

- i) a horse circling without penalty in order to get into position to jump after a run-out or a refusal;
- ii) coming to an obstacle, the finish line or a compulsory turning point at an angle or while zigzagging or turning sharply to take it without going past it.

2.4.17 Refusal

It is a **refusal** when a horse halts in front of an obstacle that it must jump, whether or not the horse knocks it down or displaces it. Provided that:

- i) Stopping in front of an obstacle without knocking it down and without backing up, immediately followed by a standing jump, is not penalised.
- ii) If the halt is prolonged or if the horse steps back either voluntarily or not even a single pace, it counts as a refusal.
- iii) If a pentathlete has knocked down the obstacle in stopping, jumps it or tries to jump it after the bell has been rung and before it has been rebuilt, he will be penalised.
- iv) If a horse slides through an obstacle, the Referee must decide immediately if it is to be counted as a refusal or as an obstacle knocked down. If the referee decides that it is a refusal, the bell is rung at once and the pentathlete must be ready to attempt the obstacle again as soon as it has been rebuilt. If the Referee decides that it is not a refusal, the bell is not rung and the pentathlete

must continue the round. The pentathlete is then penalised as for an obstacle knocked down.

- v) If the bell has been rung and the pentathlete jumps other elements of the combination in their stride, it does not entail any penalty, should this part of the combination be knocked down.
- vi) The act of showing an obstacle to the horse after a refusal and before stepping back to jump it, leads to penalty.
- vii) Attempting to jump an obstacle after two attempts on that obstacle leads to a penalty.

2.4.18 Run-out

A **run-out occurs** when the horse escapes the control of its pentathlete and avoids an obstacle, which it has to jump.

- i) It is considered to be a run-out, and is penalised as such, for a horse or any part of the horse to go past the extended line of an obstacle to be jumped, or past the extended line of an element of a combination, or of the finish line or of a compulsory turning point.
- ii) When a horse jumps an obstacle between two red flags or between two white flags the obstacle has not been jumped correctly. The pentathlete is penalised as for a run-out and they must jump the obstacle again correctly.
- iii) If the run-out is the consequence of a fall between two elements of a combination after the jump of the preceding element, the run-out is not penalised.

2.4.19 Resistance

A **resistance** occurs when the horse refuses to go forward, halts, or makes one or several more or less regular or complete half-turns, rears or steps back for whatever reason.

2.4.20 Faults in Combinations

In a combination, each element as a whole must be jumped separately and consecutively.

- i) Faults committed at any element of a combination are penalised separately.
- ii) When there is a refusal, run-out or fall, the pentathlete must retake all the jumps. Failure to do so incurs a penalty.
- iii) Penalties for faults made at each element and during the different attempts, are counted separately, and then added together.
- iv) The knockdown or displacement of the second element and/or a flag at these elements of a combination obstacle, following a fall of the pentathlete and/or horse after having jumped the preceding element, is not penalised, only the fall is penalised. The same applies if the refusal or run-out of the horse at the second element of a combination obstacle is the consequence of the fall of the pentathlete after having jumped the preceding element.

2.4.21 Particular Fault Situations

- i) Whereas knocking-down of a flag, wherever it may be on the course, does not incur any penalty, it will be penalised as disobedience leading to the knock down if it is a flag defining the limits of an obstacle, the start line or a compulsory turning point as a result of any form of disobedience. In these cases the bell is rung and the clock is stopped until replacement of the flag.
- ii) Touches and displacements of any part of an obstacle or its flags, in whatever direction, while not in the act of jumping, do not count as a knockdown. If in doubt the Referee shall decide in favour of the pentathlete.
- iii) The knockdown or displacement of an obstacle (and/or a flag) as a result of disobedience is penalised as a refusal only.
- iv) In the case of the knockdown or displacement of an obstacle (and/or a flag) as a result of disobedience and if the pentathlete needs to attempt for the second time that obstacle the bell will be rung and the clock stopped while the displacement is re-adjusted or the flag put back in position. A penalty for disobedience is imposed.

2.4.22 Falls

- i) A pentathlete is considered to have fallen when separated from the horse, which has not fallen, in such a way that they touch the ground or find it necessary in order to get back into the saddle, to use some form of support or outside assistance.



- ii) A horse is considered to have fallen when the shoulder and quarters have touched the ground or the obstacle and the ground.
- iii) A fall of a horse or a pentathlete or both is penalised wherever it takes place after crossing the start line and before crossing the finish line, whatever the cause.
- iv) At the first fall (either of the rider and/or the horse) the pentathlete is eliminated. In Relay at the team's first fall the team's ride is eliminated.

2.4.23 Timing

The time of a round is the time taken by a pentathlete to complete the round. The measured time, in seconds, is taken from the instant the forepart of the mounted horse crosses the start line to the moment when the mounted pentathlete arrives at the finish line. For the purpose of calculating the score, time will be recorded in completed seconds, whereby all positions below a second are rounded off.

2.4.24 Timekeeping

An automatic timekeeping system capable of registering time in 1/100 second is obligatory at Category A competitions and is recommended at all other official UIPM competitions.

- i) At all official UIPM competitions three stopwatches, which can be stopped and restarted without the hands returning to zero, must be provided. Two watches are required in case the automatic timing breaks down and one watch to measure the time to start after the bell has been rung, for disobediences and interruptions. The Referee and the Timekeepers must have a stopwatch.
- ii) In case of interruption, the Referee must take great care that the clock is stopped and restarted in such a manner that an interrupted time can be subtracted from the total time taken for the round. The timing equipment must be such that this procedure can be followed.

2.4.25 Time Allowed

The time allowed in Individual competitions will be calculated according to the speed of the event, depending on the distance of the course. In special circumstances the UIPM TD/NTO may determine "Time allowed". In Relay with one horse per team 10 seconds will be added.

2.4.26 Time Interruptions

If the pentathlete or the horse is not able to continue the round for any reason, the bell must be rung to stop the pentathlete. As soon as it is evident that the pentathlete is stopping, the clock will be stopped. As soon as the course is ready again the bell will be rung, and the clock will be restarted.

- i) If the pentathlete stops voluntarily to signal to the Referee that the obstacle to be jumped is wrongly built or rebuilt the clock must be stopped and the obstacle in question must be checked. If it is found that the dimensions are correct and the obstacle has been properly rebuilt and if the flags are correctly placed, the pentathlete will be penalised as for a disobedience.
- ii) If the obstacle or a part of the obstacle needs to be rebuilt or if the flags have to be put back in place, the pentathlete will not be penalised. The time of the interruption must be cancelled and the clock stopped until the moment when the pentathlete takes up their track at the point where they had stopped. Any delay incurred by the pentathlete must be taken into consideration and an appropriate number of seconds deducted from their recorded time.
- iii) While the clock is stopped, the pentathlete may move about freely until the bell signals for them to continue the round.
- iv) Falls of the horse or pentathlete during the time that a round is interrupted will still be penalised, but disobedience will not. The rules regarding elimination will be applied during the interrupted time.
- v) If the pentathlete and/or horse falls in the changeover zone the team will be eliminated.

2.4.27**Time Limit**

Time Limit is the Time Allowed +30 sec in the individual and the Time Allowed +45 sec in the Relay competitions for the course.

2.4.28**Transition in Relay Competitions**

- i) 5 minutes prior to the start of the event in the competition arena the coach must inform the horse distribution within his team. The first pentathlete starts from the changeover zone at the signal of the bell and must start from inside the changeover zone. The time will start when he crosses the Start Line (exit of the changeover area). The second pentathlete starts independently after the preceding pentathlete's horse has crossed the finish line, coinciding with the entrance of the changeover zone, with its nose.
- ii) The pentathlete that has completed the course must remain in the saddle in the zone for changeover. If a pentathlete leaves the changeover zone the pentathlete must re-enter it immediately and is penalised by 10 points. Starting from outside the changeover zone is penalised as false start. After the second pentathlete has finished the course, both pentathletes may leave the arena.

2.4.29 Safety

- i) After an athlete's fall in the warm-up area, the athletes need to be first checked and released by the paramedics to continue in the competition.
- ii) If a fall of the athlete from the horse or if both falls occurs, or in case of any other athlete's elimination reasons, the veterinary must check the horse and together with the Technical Delegate decide if the horse can continue in the next competition stage.
- iii) If the athlete encounters any problem such as cutting or ripping in the equestrian equipment of the horse, the Riding judge can take the decision to eliminate him for safety reasons.

2.5**SCORING POINTS****2.5.1****The Score**

A clear round in the time allowed shall give the pentathlete and/or team in Relay 300 points. All penalty points are deducted from this amount.

2.5.2 Positions

Positions are decided solely on the points scored. If there is a tie the optimal time is decisive. The "optimal time" is the time which is the nearest one to the Time Allowed.

2.6**INFRINGEMENTS AND PENALTIES****2.6.1****Types of Penalties**

Infringements of these Rules will be penalised by deduction of time penalties, deduction of 7 points or 10 points, elimination or disqualification.

2.6.2**Time Penalties**

Pentathletes will be penalised by deduction of 1 point for each second exceeding the time allowed in Individual competition and Relay.

2.6.3**Incorrect Dress Penalties**

In Individual and Relay, pentathletes will be penalised by deduction of 10 points for each infringement for not being correctly dressed.

2.6.4**Obstacle Penalties**

- i) In all competitions pentathletes will be penalised by deduction of 7 points for each element knocked down while jumping;



2.6.5 Particular Relay Penalties

- ii) In all competitions, pentathletes will be penalised by deduction of 10 points: - for each disobedience;
 - for each disobedience leading to the knocking down of an element or a flag defining an obstacle, the limits of the starting line or of a compulsory turning point;
 - for each forbidden attempt of jumping the same element.

There will be a deduction of 10 points for not communicating the start order or for exiting the Relay zone out of turn.

2.6.6 Other 10 Point Penalties

The following incur 10 point penalties:

- i) each occasion of jumping more than the allowed number of jumps in the warm-up arena;
- ii) not stopping when the bell is rung during the round;
- iii) all unauthorised assistance;
- iv) entering the arena on foot after the beginning of the event;
- v) exiting the arena dismounted except in cases where the pentathlete or horse is injured;
- vi) for incorrect use of the whip and/or spurs, after or without warning.
- vii) not patting the horse after finishing the course

2.6.7 Elimination

The following incur elimination:

- i) jumping an obstacle in the wrong direction;
- ii) starting before the signal is given and/or jumping an obstacle before the start of the round;
- iii) jumping the first obstacle of a competition without having crossed the starting line;
- iv) jumping an obstacle which had been knocked down before it has been rebuilt;
- v) jumping an obstacle without waiting for the bell;
- vi) jumping an obstacle after two refusals or run-outs at the same obstacle;
- vii) a pentathlete and/or horse leaving the arena before the end of the round;
- viii) a pentathlete or horse being unable to continue the course;
- ix) the first fall of the athlete from the horse or both fall;
- x) retiring from the competition during the ride;
- xi) exceeding the time limit;
- xii) not jumping in prescribed order and direction or omitting to jump an obstacle
- xiii) jumping out of the competition arena;
- xiv) after the first refusal or run-out, not attempting to jump an obstacle or all the elements of a combination the second time before attempting the next one;
- xv) not crossing the finish line mounted before leaving the arena;
- xvi) after 3 refusals and/or run-outs;
- xvii) not entering the arena on the third call;
- xviii) continuing the warm-up or the competition without headgear;
- xix) false start in the Relay change-over;
- xx) horse's resistance for more than 30 seconds.

2.6.8 Disqualification

A pentathlete or team is disqualified for:

- i) unsportsmanlike or contempt of officials;
- ii) rapping or beating a horse and all other cases of cruelty and/or ill treatment of a horse;
- iii) using an unauthorised whip or spurs or hat after the control in the arena, warm-up arena or elsewhere in the proximity of the arena.

**POINTS PENALTY
TABLE**

RIDING

Appendix: 2A

The pentathlete infringes the rules and is penalised for:	Article	Penalty
Each second that exceeds the time allowed	2.6.2	1 point
Each element knocked down while jumping	2.6.4 i)	7 points
Contravening clothing regulations	2.6.3	10 Points
Disobedience (each occasion)	2.6.4 ii)	
Each disobedience leading to the knock-down of an element or a flag defining an obstacle, the limits of the starting line or of a compulsory turning point	2.6.4 ii)	
Each forbidden attempt of jumping the same element	2.6.4 ii)	
Coach not informing the Relay start order	2.6.5	
Exiting the Relay changeover zone out of turn	2.6.5	
Not patting the horse after finishing the course	2.6.6 vii)	
Each occasion of jumping over the allowed number of jumps in the warm-up arena	2.6.6 i)	
Not stopping when the bell is rung during the round	2.6.6 ii)	
All unauthorised assistance	2.6.6 iii)	
Entering the arena on foot after the beginning of the event	2.6.6 iv)	
Exiting the arena dismounted, except for injury of horse	2.6.6 v)	
Incorrectly using the whip	2.6.6 vii)	

(Note: for explanation and application, please refer to Chapter 2.6)

**POINTS PENALTY
TABLE**
RIDING
Appendix: 2A

The pentathlete infringes the rules and is penalised for:	Article	Penalty
Jumping an obstacle in the wrong direction	2.6.7 i)	Elimination (0 points in Riding Event)
Starting before the signal is given and/or jumping an obstacle before the start of the round	2.6.7 ii)	
Jumping the first obstacle of a competition without having crossed the start line	2.6.7 iii)	
Jumping an obstacle which had been knocked down before it has been rebuilt	2.6.7 iv)	
Jumping an obstacle without waiting for the bell	2.6.7 v)	
Jumping an obstacle after two refusals or run-outs at the same obstacle	2.6.7 vi)	
A pentathlete and/or horse leaving the arena before the end of the round	2.6.7 vii)	
A pentathlete or horse being unable to continue the course	2.6.7 viii)	
The first fall of the athlete from the horse or both fall	2.6.7 ix)	
A pentathlete retiring from the competition during the ride	2.6.7 x)	
A pentathlete or team for exceeding the time limit	2.6.7 xi)	
Not following the plan of the course; not jumping in prescribed order or omitting to jump an obstacle	2.6.7 xii)	
Jumping out of the competition arena	2.6.7 xiii)	
After the first refusal or run-out not attempting to jump an obstacle or all the elements of a combination the second time before attempting the next one	2.6.7 xiv)	
Not crossing the finish line mounted before leaving the arena	2.6.7 xv)	
After 3 refusals and/or run outs	2.6.7 xvi)	
Not entering the arena at the third call	2.6.7 xvii)	
False start in the Relay Change-over	2.6.7 xix)	
Continue the warm up and the competition without headgear	2.6.7 xviii)	
Horse's resistance for more than 30 seconds	2.6.7 xx)	Elimination
unsportsmanlike behaviour or contempt of officials	2.6.8 i)	Disqualification
raping a horse and all other cases of cruelty and/or ill treatment	2.6.8 ii)	
using an unauthorised whip or spurs or hat after the control in the arena, warm-up arena or elsewhere in the proximity to the show ground	2.6.8 iii)	
Inappropriate use of the whip or spurs	2.8.4	10 Points or Disqualification

**POINTS PENALTY
TABLE**

RIDING

Appendix: 2B

Arena >2500m²:
target speed of 350 m/minute
Individual

Length of Course	Time allowed	Time Limit
350m	60 sec	90 sec
355m	61 sec	91 sec
360m	62 sec	92 sec
365m	63 sec	93 sec
370m	63 sec	93 sec
375m	64 sec	94 sec
380m	65 sec	95 sec
385m	66 sec	96 sec
390m	67 sec	97 sec
395m	68 sec	98 sec
400m	69 sec	99 sec

**TIME PENALTY
for Individual
Competition and
Relay +1sec = -1 point**

+1s = - 1 p	+16 = - 16	+31 = - 31
+2 = - 2	+17 = - 17	+32 = - 32
+3 = - 3	+18 = - 18	+33 = - 33
+4 = - 4	+19 = - 19	+34 = - 34
+5 = - 5	+20 = - 20	+35 = - 35
+6 = - 6	+21 = - 21	+36 = - 36
+7 = - 7	+22 = - 22	+37 = - 37
+8 = - 8	+23 = - 23	+38 = - 38
+9 = - 9	+24 = - 24	+39 = - 39
+10 = - 10	+25 = - 25	+40 = - 40
+11 = - 11	+26 = - 26	+41 = - 41
+12 = - 12	+27 = - 27	+42 = - 42
+13 = - 13	+28 = - 28	+43 = - 43
+14 = - 14	+29 = - 29	+44 = - 44
+15 = - 15	+30 = - 30	+45 = - 45

For Calculation of Time Penalties:

Time: 70.1 seconds is recorded as 70 seconds.

Time: 70.9 seconds is recorded as 70 seconds.



FENCING

PART A

THE EVENT

3.1 PRESENTATION OF THE EVENT

1 Description

2 Terms Commonly Used

3.2 AUTHORITIES

1 Fencing Director
2 Referee
3 Ground Judges
4 Superintendents of Apparatus
5 Timekeepers

6 Pool Sheet Scorers
7 Repairers
8 Experts in Electrical Judging
9 Medical Staff
10 Bonus Round

3.3 ORGANISATION AND SCHEDULE

1 Ranking Round
1.1 Single Pool
1.2 Warm up
1.3 Order of Matches
1.4 Number of Hits
1.5 Order of Bouts

2 Bonus Round
2.1 Bout
2.2 Start List
2.3 Order of Bouts

3.4 CONDUCT OF THE COMPETITION

1 Control on the Piste
2 Non-regulation Equipment
3 Coming on Guard
4 Beginning, Stopping and Restarting the Bout
5 Duration of Bouts
6 Holding the Épée
7 Making a Hit
8 The Target
9 Displacing the Target and Passing the Opponent

10 Use of the Non-sword Hand and Arm
11 Crossing the Limits of the Piste
12 Materiality of Hits
13 Validity or Priority of Hits
14 Annulment of Hits
15 Doubtful Hits and Double Defeats
16 Accidents, Withdrawal of a Pentathlete
17 Recognition of Results

**3.5
SCORING OF POINTS**

- | | | | |
|----------|----------------------------------|----------|-----------------------|
| 1 | Ranking Round | 2 | Bonus Round |
| 1.1 | Points in Individual Competition | 2.1 | Points in Competition |
| 1.2 | Points in Relay Competition | 2.2 | Tie |
| 1.3 | Tie | 2.3 | DNS/DNF |

**3.6
INFRINGEMENTS AND
PENALTIES**

- | | | | |
|----------|--------------------|----------|--------------------|
| 1 | Principles | 3 | Groups of Offences |
| 2 | Types of Penalties | | |

ANNEXES

Appendix 3A

PENALTY TABLE

Appendix 3B

POINTS TABLES

- | | | | |
|-----------|------------|-----------|-----------------------|
| 1. | Individual | 2. | Relay with 2 Athletes |
|-----------|------------|-----------|-----------------------|

Appendix 3C

TEAM CIRCULATION TABLE

Appendix 3D

GUIDELINES FOR TESTING THE FENCING LADDER TOURNAMENT 2014

FIGURES

Figure 3

Referee Signals and Commands



3

EVENT RULES – FENCING

PART A

THE EVENT

3.1 PRESENTATION OF THE EVENT

3.1.1 Description

- i) The Fencing Ranking Round event is organised as a single pool with electric épée and is organised indoors. If the fencing ranking round is to be held outdoors, this must be indicated explicitly in the competition invitation letter.
- ii) In Olympic Games, Youth Olympic Games and World Cup Finals, the Fencing Ranking Round takes place the day before the Semi-Finals for both genders.
- iii) The Fencing Bonus Round takes place in the Individual Semi-Finals, Finals and Relay events of all Category "A" competitions and is organised on a single piste in a one-on-one format for bonus points.
- iv) The Fencing Bonus Round must take place on the FOP of the Ride/Laser Run, after the Riding event and prior to the Swimming event in Olympic Games, Youth Olympic Games, World Cup Finals and World Championships. At all other UIPM Category A competitions, under special circumstances, the fencing Bonus Round can take place immediately after the Fencing Ranking Round on the Fencing FOP. In such case, a special set up, including show piste, backdrop and spectator seats, must be made.

3.1.2 Terms Commonly Used

- i) **Assaults and bouts:** Friendly combat between two fencers is called an assault. A bout is when the total of assaults is recorded to determine a result.
- ii) **Match:** The aggregate of bouts fought between fencers of two different teams is called a match.
- iii) **Competition:** A competition is the aggregate of bouts (individual competitions) or matches (team relay competitions) required to determine the winner of the event.
- iv) **Fencing time:** "Fencing time" is the time required to perform one single fencing action.
- v) **The attack:** An action is simple when executed in one movement and is either:
 - a) direct (in the same line) or
 - b) indirect (in another line).An action is compound when executed in several movements.
- vi) **The riposte:** A riposte may be immediate or delayed, depending on what action takes place and the speed at which it is carried out. Ripostes are:
 - a) Simple, direct
 - 1) Direct riposte: A riposte which hits the opponent without leaving the line in which a parry was made.
 - 2) Riposte along the blade: A riposte which hits the opponent by grazing along the blade after a parry.
 - b) Simple, indirect
 - 1) Riposte by disengagement: A riposte which hits the opponent in the opposite line to that in which the parry was formed (by passing under the opponent's blade if formed in the high line, and over the blade if the parry was formed in the low line).
 - 2) Riposte with a coupé: A riposte which hits the opponent in the opposite line to that in which the parry was formed (the blade always passing over the opponent's point).
 - c) Compound: A riposte executed in more than one fencing time.

3.2 AUTHORITIES

3.2.1

The LOC must appoint a Fencing Director, who is responsible for:

- i) the overall correct conduct of the fencing event;
- ii) deciding on verbal complaints against decisions of the Referee;
- iii) excluding officials and spectators from the event if requested by a Referee;
- iv) the supervision of all other authorities and auxiliaries as specified in 3.2.2 – 3.2.9.

3.2.2

A **Referee** is appointed to each piste and, if necessary, may be assisted by two Ground Judges. The Fencing Director must appoint substitutes. At Olympic Games and World Championships the Referees must be selected from amongst International Judges for épée, recognised by UIPM or FIE. The Referee is responsible for:

- i) directing the bout, moving along the piste to follow the phases of the fencing and the appearance of light signals;
- ii) calling the roll of pentathletes;
- iii) judging hits and awarding or refusing to award a hit;
- iv) controlling the weapon, equipment and clothing of each pentathlete at the beginning of each bout and each time any item is changed;
- v) supervising the proper functioning of the electric apparatus, verifying the apparatus and localising any fault whenever necessary and upon request by a team representative or pentathlete;
- vi) maintaining order in the bouts over which he presides;
- vii) penalising pentathletes by awarding penalty points or excluding them from the event and requesting the exclusion of any other person present, including spectators, by the Fencing Director. Exclusion may happen with or without a warning;
- viii) recording a case of elimination or disqualification on the pool sheets. The pentathlete must be notified.

3.2.3

The **Ground Judges** are responsible for informing the Referee about any use of the non-weapon arm and any striking of an invalid surface by a fencer.

3.2.4

Superintendents of Apparatus;

3.2.5

Timekeepers

3.2.6

Pool sheet scorers;

3.2.7

Repairers for personal equipment and technical facilities such as electrical apparatus;

3.2.8

Experts in Electrical Judging;

3.2.9

Medical Staff;

3.2.10

In addition, for the Fencing Bonus Round:

- i) two Call Room Equipment Judges who check clothing, point courses, weight of the point, reserve equipment, in the call area and are responsible for ensuring that the pentathletes are ready for the piste prior to their bout .
- ii) two Referee's Assistants to check the pentathletes' épées with regard to the lightening of the system and the isolation of the guard just prior to the athletes' entry onto the piste.



3.3 ORGANISATION

3.3.1 RANKING ROUND

3.3.1.1 Single pool

In the pool, unique teams meet in a prearranged order as indicated in Appendix 3C. The event will be conducted in rounds using all available pistes simultaneously. All teams begin each round at the same time.

3.3.1.2

Warm up time is given, according to LOC prior to the competition. Either the competition FOP can be used or a separate warm up area with pistes must be provided.

3.3.1.3 Order of Matches

In individual competition matches are fought so that each pentathlete in one team meets all pentathletes in the opposing team(s). Pentathletes in the same team must meet before the beginning of the first match against other teams (round 0). In the Relay competition competitors meet only the pentathlete with the same number in the opposite team.

3.3.1.4 Number of Hits

- i) In the **Individual** competition, all bouts are for one decisive hit judged with an electrical scoring apparatus of a design approved by UIPM or FIE.
- ii) In the **Relay** competition, the number of the hits of each bout depends on the number of the teams; each hit will be of one minute duration.

3.3.1.5 Order of Bouts

For each group, the draw will be made by the TD at the TM for Piste No 1 by drawing one number. That team will be Team 1. The next team, identified in English alphabetical order, will be Team 2, etc. Teams will be placed on pistes as shown in Appendix 3C. If a nation has 2 or more teams taking part in a competition or group, they will meet in the first rounds of the Fencing event according to Appendix 3C.

- i) In the Individual competition between members of the same team the order of the bouts is:
 - a) Team of 3 fencers: 1-3, 2-1, 3-2
 - b) Team of 4 fencers: 1-3, 2-4, 2-1, 4-3, 1-4, 3-2.
- ii) In the Individual competition in a match between two teams the order of the bouts is:
 - a) Team of 2 fencers: 1-3, 1-4, 2-4, 2-3
 - b) Team of 3 fencers: 1-4, 2-5, 3-6, 5-1, 6-2, 4-3, 1-6, 2-4, 3-5
 - c) Team of 4 fencers: 3-8, 4-6, 1-7, 2-5, 6-3, 8-1, 5-4, 7-2, 1-6, 3-5, 2-8, 4-7, 5-1, 6-2, 7-3, 8-4.
- iii) In the Relay competition numbers 1 and 2 meet the fencers holding the same numbers from the opposite team that is number 1 against number 1, number 2 against number 2 in this order.
- iv) If the total number of fencers in an Individual competition is less than 20, it will be necessary to fence two rounds consecutively, without fencers leaving the piste. In this case they will have one minute for each bout. The number of hits must be the same for all groups.
- v) If a match is running over time, following a decision of the Fencing Director or the Referee on the piste, fencers or teams must fight or continue their match on two pistes.

3.3.2 BONUS ROUND

3.3.2.1

Each bout is for one hit in 30 seconds in Individual and per team member in Relay.

3.3.2.2

The Start List for the Fencing Bonus Round is based on the results of the Fencing Ranking Round. The points achieved by the pentathletes in the Ranking Round are carried over to the Bonus Round.

3.3.2.3 Order of Bouts

- i) The first bout is the pentathlete/team ranked last against the pentathlete/team ranked next to last (i.e. one position above)
- ii) The winner of the bout remains on the piste and the referee calls the next pentathlete/team, ranked 3rd from last in the start list
- iii) The Fencing Bonus Round continues until all pentathletes have fenced
- iv) In the Relay competition numbers 1 and 2 meet the fencers holding the same numbers from the opposite team that is number 1 against number 1, number 2 against number 2 in this order for the first match of the last two placed teams. The winning team member stays on the piste to face the same number (e.g. nr.2-2) of the next team.
- v) In the Mixed Relay, the team members fence the same gender competitor. The first pentathletes on the piste are the women members of the last two placed teams, then the men. The winning team member stays on the piste to face the male team member of the next team.

3.4 CONDUCT OF THE COMPETITION

3.4.1 Control on the Piste

- i) A final check of weapons, clothing and equipment is made by the Referee on the piste at the beginning of each bout. Any electrical equipment rejected during this control may be repaired in a facility assigned by the Organising Committee, but only after the control of all other competitors' equipment has been completed.
- ii) The Referee will in every case before each bout ensure that the guarantee label is present on each pentathlete's clothing; that each pentathlete is using appropriate chest protection; that the blade and mask of each pentathlete is marked; and that the insulation of the wires inside the guard and the pressure and travel of the spring in the point of épées conform with the Rules. Checking the insulation of the wires, the travels and the pressure of the spring will be repeated each time a weapon is changed.
- iii) The Referee will check that each pentathlete is not equipped with electronic communication equipment which would allow anyone off piste to communicate with the pentathlete during the bout.
- iv) At the beginning of the bout the Referee will confirm that each pentathlete has placed such reserve equipment (that has been checked) near the appropriate end of the piste of the pentathlete concerned.
- v) For the Fencing Bonus Round, the pentathletes/teams will compete under the same bout rules as above except that the controls will be conducted.
 - 3.4.2 in the call room, as to clothing, point courses, weight of the point and reserve equipment.
 - 3.4.3 just prior to entry on the piste with regard to the lightening of the system and the isolation of the guard.

3.4.2 Non-regulation Equipment

- i) Whenever a pentathlete is found to possess equipment that does not conform to these Rules, the UIPM Equipment Regulations or is defective, the equipment will be confiscated by the Referee on the piste immediately and checked. It will be returned to the pentathlete only after adjustment according with the rules and after a further check.
- ii) If during a bout an irregularity concerning the equipment is found which could have been caused by conditions during the bout and the épée or bodywire in question have ceased to function, no penalty will be imposed. A hit made with such defective equipment will be valid. In all other cases of irregular equipment found during a bout, a penalty will be imposed according to Rule 3.6.3 i).
- iii) The Referee will apply penalties according to Rule 3.6.3 i) if a pentathlete appears on piste:



- a) with only one regulation weapon conforming to the Rules and Regulations
 - b) with only one regulation body wire
 - c) with a weapon or body wire which does not work or which does not conform with a Rule or Regulation
 - d) whose weapon, at the moment he/she presents himself/herself on guard and ready to fence, has a curve which is more than 1cm
 - e) with clothing which does not conform to the Rules.
- iv) If, when a pentathlete appears on piste, it is established that the equipment used by the pentathlete does not bear the marks applied at the preliminary check, the Referee will:
- a) annul the hit, if any, scored by the pentathlete at fault;
 - b) penalise the pentathlete as specified in Rule 3.6.3 ii);
 - c) if it is established that the equipment does not conform to the Rules nor Regulations in a way not covered by the preliminary check, the Referee will penalise the pentathlete as specified in Rule 3.6.3 ii).
- v) If a pentathlete is on piste and it is established that the equipment used by the pentathlete:
- a) has passed the preliminary check but presents irregularities which could have been deliberately made or shows apparent marks of a preliminary check which have been imitated or transferred;
 - b) has been altered in any way to interfere with the recording of hits or create non-functioning of the apparatus;
 - c) is equipped with electronic communication equipment (permitting a person off the piste to communicate with the pentathlete during the bout), the Referee must immediately confiscate the equipment and have it examined by the expert on duty. If the expert on duty confirms the fact of violation of the rules the Referee will penalise the pentathlete as specified in Rule 3.6.3 iv).

3.4.3 Coming on Guard

- i) The pentathlete called first must go to the right of the Referee.
- ii) The Referee places each pentathlete so that the front foot of each pentathlete is 2 metres from the centre line of the piste (that is, behind the "on-guard" lines).
- iii) Pentathletes are put on guard, at the beginning of the bout or subsequently, in the centre of the width of the piste.
- iv) When placed on guard during a bout, the distance between the two pentathletes must be such that, in the on-guard position, with arms straight and épées in line, the points of the two épées cannot make contact.
- v) Pentathletes may not be replaced on guard, at their correct distance, so as to place behind the rear line of the piste a pentathlete who was in front of that line when the bout was halted. A pentathlete who already had one foot behind the rear line will remain in that position when re-taking guard.
- vi) A pentathlete crossing the lateral boundaries of the piste, may be put back on guard at the correct distance even if this places the pentathlete behind the rear line and thereby causes a hit to be awarded against them.
- vii) Pentathletes come on guard when the Referee gives the order "**En garde**" ("On guard"), after which the Referee asks, "**Etes-vous prêt?**" ("Are you ready?"). On receiving an affirmative reply, or in the absence of negative reply, the Referee gives the command for fencing to start: "**Allez**" ("Play").
- viii) Pentathletes must come on guard correctly and remain completely still until the command "**Allez**" ("Play") is given by the Referee.

3.4.4 Beginning, Stopping and Restarting the Bout

- i) A pentathlete or team, completely equipped, with all equipment conforming to the regulations and ready to fence, must be present at the time and place appointed for the beginning of the event.
- ii) If a pentathlete is not present at the place and time assigned for the beginning of the event, there will be two repetitions of the call by the Referee on the

piste at intervals of one minute. A pentathlete not appearing by the third call will be penalised as specified in Rule 3.6.3 iv).

- iii) A pentathlete who has received prior warning to fence a bout and does not present at the first order when called by the Referee on the piste, incurs a penalty as specified in Rule 3.6.3 i).
- iv) The start of the bout is signalled by the word **"Allez"** ("Play"). No movement made or initiated before the command **"Allez"** ("Play") is counted.
- v) The fact that the pentathletes have been again put "on guard" and the command **"Allez"** ("Play") has been given, or even that 2 pentathletes have maintained a passive attitude after this command, does not mean that the bout has effectively begun. In order for the bout to be considered as effectively begun, the pentathletes must have engaged in a fencing action that affects the equipment in use.
- vi) The bout stops on the word **"Halte"** ("Halt") except in the case of special events which modify the regular and normal conditions of the bout.
- vii) As soon as the command **"Halte"** ("Halt") has been given, a pentathlete may not start a new action; only movement that began before the command was given remains valid.
- viii) If a pentathlete stops before the command **"Halte"** ("Halt") and is hit, the hit is valid.
- ix) Fencers, whether on or off the piste, must not remove masks until the Referee on the piste has given the command **"Halte"** ("Halt"). Removing a mask before such command is a disciplinary offence and penalised as specified in Rule 3.6.3 i).
- x) The command **"Halte"** ("Halt") is also given if the match play is dangerous, confused, or contrary to the Rules, if a pentathlete is disarmed or leaves the piste, or if, while retiring, the pentathlete approaches too near spectators or the Referee.
- xi) Between the commands **"Allez"** ("Play") and **"Halte"** ("Halt"), the Referee on the piste must not allow a pentathlete to leave the piste, save in exceptional circumstances. If a pentathlete does so without permission the pentathlete is liable incur a penalty as specified in Rule 3.6.3 i).

3.4.5

Duration of Bouts

- i) Duration of a bout mean the effective duration, that is the total time between the orders **"Allez"** ("Play") and **"Halte"** ("Halt").
- ii) The effective duration of the bout is one minute, not including interruptions.
- iii) Any hit arriving ("coup lancé") before or at the moment of the **"Halte"** ("Halt") command given by the Referee on the piste is valid.
- iv) The duration of the bout is registered by the Referee or by the time-keeper.
- v) Fencers may ask how much time they have left to fence any time that the Fencing is interrupted, unless a time recording device is visible on the recording apparatus.
- vi) Fencers cannot interrupt the bout to ask the time and if they do so they will be penalised according to the Rule 3.6.3 i).
- vii) Fencers who improperly attempt to prolong interruptions to the bout will be penalised as specified in Rule 3.6.3 i).
- viii) At the end of the regular fencing time, if the clock is linked to the scoring apparatus, it must automatically set off an audible signal and cut off the scoring apparatus, without cancelling the hits registered before the disconnection. The bout stops with the audible signal.
- ix) If the clock is not linked to the scoring apparatus, the time-keeper must shout **"Halte"** ("Halt"), or operate the sound signal which stops the bout; in which case a hit arriving is not valid.
- x) Should there be a failure of the clock or an error by the time-keeper, the Referee must estimate how much fencing time is left.

3.4.6

Holding the Epée

- i) Defence must be effected exclusively with the guard and the blade used either separately or together.
- ii) If the handle has no special device or attachment or special shape (e.g. orthopaedic), a pentathlete may hold the épée in any way and may alter the position of their hand on the handle during the bout. However, the épée must not be transformed – either permanently or temporarily, in an open or disguised manner – into a throwing weapon. It must be used without the hand leaving the hilt and without the hand slipping along the hilt from front to back during an offensive action.



3.4.7

Making a Hit

- iii) When the handle has a special device or attachment or has a special shape (e.g. orthopaedic or French grip) the épée must be held in such a way that the upper surface of the thumb is in the same plane as the groove in the épée blade. If not, a red card penalty will be applied.
 - iv) The épée must be used with one hand only. A pentathlete may not change hands until the end of the bout, unless the Referee on the piste gives special permission in the case of injury to the hand or arm.
- i) The épée is a thrusting weapon. Attacks are made with the point only.
 - ii) Pushing or letting the point of the épée drag on a conductive piste is forbidden during the bout (between "Allez" (Play) and "Halte" ("Halt"). Placing the épée on the conductive piste at any time to straighten it is also forbidden. Breaking this rule will be penalised according to Rule 3.6.3 i).
 - iii) A flèche attack, even made by running and/or going past the opponent or advancing vigorously, as long as it happens without brutality or violence, is allowed, even if it ends in one or several or systematic corps à corps. A flèche attack resulting in a shock that jostles the opponent, however, is considered an act of intentional brutality and will be penalised according to Rule 3.6.3 i).
 - iv) In case of a flèche attack made by running and/or going past the opponent without a corps à corps, the Referee on the piste must not call "Halte" too soon, in order not to annul a possible riposte. A pentathlete who when making such a running flèche without hitting the opponent, crosses the lateral boundaries of the piste will be penalised under Rule 3.6.3 i).
 - v) When a corps à corps occurs, which means that the two pentathletes enter in immediate contact to each other, the Referee on the piste must stop the bout.
 - vi) It is forbidden for a pentathlete to cause a corps à corps intentionally to avoid being hit or to jostle an opponent. This will be penalised according to Rule 3.6.3 i).
 - vii) Fencing at close quarters is allowed as long as the pentathletes can wield their épées correctly and the Referee on the piste can follow the phase of the fencing.
 - viii) Actions ended by a fall are not valid. Any hit must be annulled without other penalties.
 - ix) All irregular actions (disorderly fencing, irregular movements on the piste, hits achieved with violence, blow with guard or pommel, abuse of mask equipment) are strictly forbidden and will be penalised according to Rules 3.6.3 i) or 3.6.3 ii). Should such an offence occur, any hit scored by the pentathlete at fault is annulled.

3.4.8

The Target

The target includes the whole of the pentathlete's body, including their clothing and equipment.

3.4.9

Displacing the Target and Passing the Opponent

- i) Displacing the target and ducking are allowed even if during the action the unarmed hand comes into contact with piste.
- ii) It is forbidden to turn one's back on an opponent during the bout. Should such an offence occur, the Referee will penalise the pentathlete at fault as specified in Rule 3.6.3 i), and any hit scored by the pentathlete at fault is annulled.
- iii) When a pentathlete goes completely past the opponent during a bout, the Referee on the piste must immediately call "Halte" ("Halt") and replace the pentathletes in the positions that they occupied before the passing took place.
- iv) When hits are made while a pentathlete passes the opponent, a hit made immediately is valid. A hit made after passing an opponent by the pentathlete that has made the passing movement is annulled, but the hit made immediately, even when turning round, by the pentathlete who has been subjected to the offensive action, is valid.
- v) If during a bout a pentathlete that has made a flèche attack has a hit registered and continues to run beyond the extreme limit of the piste sufficiently far to cause the spool or the connecting line to the spool to be torn out, the hit received will not be annulled.

3.4.10 Use of the Non-sword Hand and Arm

- i) The use of the non-sword hand and arm to carry out an offensive or defensive action is forbidden. Should such an offence occur, the hit scored by the pentathlete at fault is annulled. The Referee will penalise the pentathlete at fault as specified in Rule 3.6.3 ii).
- ii) During the fight, the pentathlete must not, under any circumstances, take hold of any part of electrical equipment with their non-sword hand. Should such an offence occur any hit scored by the pentathlete at fault is annulled. The Referee will penalise the pentathlete at fault as specified in Rule 3.6.3 i).
- iii) If during the bout the Referee notices that one of the pentathletes is making use of their non-sword arm and/or hand, the Referee can seek help from two neutral ground judges who will be designated by the Fencing Director. These judges, one on each side of the piste, will each watch one pentathlete and will indicate, by raising their hand or when asked by the Referee on the piste, if the non-sword arm or hand has been used.

3.4.11 Crossing the Limits of the Piste

- i) Stopping the bout
 - a) When a pentathlete crosses one of the lateral boundaries of the piste with one or both feet, the Referee on the piste must immediately call "Halte" ("Halt").
 - b) If the pentathlete goes off the piste with both feet, the Referee must annul everything that occurred after the boundary has been crossed, except a hit received by the pentathlete who has crossed the boundary even after they have crossed it, provided that this hit results from a simple and immediate action.
 - c) However, a hit scored by the pentathlete that leaves the piste with one foot is valid provided that the action was started before the "Halte" ("Halt").
 - d) If a pentathlete leaves the piste with both feet, only a hit made by the pentathlete that remains on the piste with at least one foot is valid, even in the case of a double hit.

ii) Rear limit

A hit will be scored against a pentathlete who crosses the rear limit of the piste completely i.e. with both feet.

iii) Lateral boundaries

- a) If a pentathlete crosses one of the lateral boundaries of the piste, they must step back one meter from the point where they left the piste; if they go off the piste during an attack they must return to the position they occupied when they started their attack and then step back a meter. If this places a pentathlete with both feet beyond the rear limit of the piste, the pentathlete concerned is considered as having been hit.
- b) A pentathlete who crosses one of the boundaries of the piste with one or both feet – e.g. when making a flèche attack – to avoid being hit will be penalised according to Rule 3.6.3 i).
- c) A pentathlete who involuntarily crosses one of the boundaries of the piste as the result of an accidental cause (such as a collision or jostling) incurs no penalty.

3.4.12 Materiality of Hits

- i) The materiality of a hit is established according to the indications of the electrical apparatus and, when necessary, by consulting the judges.
- ii) Only the indications of the electrical apparatus as indicated by its own lamps or by the extension lamps can be taken into consideration in judging a hit. Under no circumstances can the Referee declare a pentathlete to be hit unless the hit has been properly registered by the electrical apparatus (except as provided for by the MP 2017 Equipment Regulations 3.4).
- iii) The Referee will annul the hit registered by the electrical apparatus in case of notification by the Ground Judge according to Rule 3.2.3.



3.4.13 Validity or Priority of Hits

- i) As soon as the bout has stopped, the Referee briefly analyses the movements which composed the last fencing phase.
- ii) After reaching a decision regarding the materiality of a hit, the Referee, by applying the rules, will decide which pentathlete was hit, whether both were hit (double hit), or whether there was no valid hit.
- iii) The Referee must use the signals as shown in figure 3.

3.4.14 Annulment of Hits

- i) The Referee disregards hits which have been registered as a result of the following actions:
 - a) started before the command "**Allez**" ("Play") or after "**Halte**" ("Halt");
 - b) caused by the meeting of the points of the epees or hits made on the ground where is not insulated;
 - c) which are made on any object other than the opponent, including their equipment.
 - d) Any pentathlete who intentionally causes the apparatus to register a hit by placing their point on any surface other than that of their opponent will be penalised as specified in Rule 3.6.3 ii).
- ii) The Referee must take note of possible failures of electrical equipment and must annul the last hit registered in the following circumstances:
 - a) If a hit made on the guard of the pentathlete against whom the hit was registered or on the conductive piste causes the apparatus to register a hit;
 - b) if a hit properly made by the pentathlete against whom the hit was registered does not cause the apparatus to register a hit;
 - c) if the apparatus fortuitously registers a hit against a pentathlete against whom there has been, for example, a beat on the blade, some movement of the opponent, or vibration on the piste transmitted to the central apparatus; or as a result of any cause other than a properly made hit;
 - d) if a hit is annulled the subsequent hit made by their opponent;
 - e) if a double hit is registered but one hit is valid and the other is not valid (such as a hit made on surface other than opponent or a hit made leaving the piste) only the valid hit is scored.
- iii) The Referee must also apply the following rules regarding the annulment of hits:
 - a) Only the last hit which precedes the establishment of the failure of the apparatus may be annulled and then only if it is the pentathlete against whom the hit was registered who is placed at a disadvantage by the failure.
 - b) The failure must be determined by tests made immediately after the bout is stopped, under the supervision of the Referee and without changing any part of the equipment in use.
 - c) With these tests, one is trying only to establish whether there is a material possibility of a mistake in the judgment as a result of a fault. The location of this fault in the electrical equipment, including that of either of the pentathletes, is unimportant in reaching a decision.
 - d) It is not necessary, in order to justify the annulment of a hit, that the failure in question repeats itself each time a test is made, but it is essential that the fault be established by the Referee without the possibility of doubt at least once.
 - e) A pentathlete who makes any modification in, or changes to their equipment without being asked by the Referee to do so, before the judgment is pronounced, loses the right to the annulment of the hit. Similarly, after again coming on guard and after the bout has effectively recommenced, a pentathlete cannot claim the annulment of a hit registered against them before the said recommencement of the bout.
 - f) If the incidents mentioned occur as a result of a pentathlete's body wire

being unplugged, either near the hand or at the back of the pentathlete, they cannot justify an annulment of a hit. However, if the safety device prescribed by Rule B 3.10.2 iv) is missing or not functioning, the hit must be annulled if the plug at the pentathlete's back has become unplugged.

- g) The fact that the épée of an pentathlete has large or small areas of insulation formed by oxidation, glue, paint or other material on which the opponent's hits can cause a hit to be signalled, or that the electric tip is badly fixed to the end of the blade so that it can be unscrewed or tightened by hand, cannot justify any annulment of the hits registered against that pentathlete.
- h) When a pentathlete against whom the hit has been registered has broken their épée, the hit must be annulled unless the breaking of the épée occurred clearly after the hit was registered.
- i) If a pentathlete tears the conductive piste by a hit made on the ground and, at the same time, the apparatus registers a hit against their opponent, the hit must be annulled. Whenever, owing the same accidental cause, tests cannot be made, the hit must be considered as doubtful and must be annulled.

3.4.15 Doubtful Hits and Double Defeats

- i) The Referee must pay particular attention to hits which are not registered or which are registered abnormally. Should such defects be repeated, the Referee on the piste must ask an expert technician on duty to verify that the equipment conforms to these Rules. The Referee ensures that nothing is altered either to the pentathlete's equipment or to the whole of the electrical apparatus before the expert makes the check.
- ii) The Referee must supervise the condition of the conductive piste. They must not allow the bout to commence or to continue if the conductive piste has holes in it which might affect the proper registering of hits or cause accidents.
- iii) Double hits are annulled and the pentathletes are put on guard in the position they held when the double hit occurred.
- iv) If a double hit is registered and one hit is valid and the other is not valid (such as a hit made on surface other than opponent or a hit made leaving the piste) only the valid hit is scored.
- v) If the registering of a hit made by the pentathlete against whom the hit was registered is annulled by a subsequent hit made by their opponent, only the valid hit is scored.
- vi) If the time limit expires before a winning hit has been made, both pentathletes are counted as being hit and a defeat is scored against both of them.

3.4.16 Accidents, Withdrawal of a Pentathlete

- i) If an accident occurs during the bout and is properly attested by a member of the medical staff on duty, the Referee on the piste will allow a break in the bout for up to 5 minutes. This break should be timed from the point when the medical staff on duty give their opinion and be strictly reserved for the treatment of the accident which brought it about. If the member of the medical staff in duty considers, before or at the end of the 5 minute break, that the pentathlete is incapable of continuing the bout, the pentathlete must withdraw.
- ii) For the remainder of the day, a pentathlete who already has been allowed a break can only be allowed a further break on account of a different injury.
- iii) For indisposition, including cramp, a pentathlete may receive two periods, each of 5 minutes for recovery.
- iv) A pentathlete demanding a break that is deemed by the member of the medical staff on duty to be unjustified, will be penalised by the Referee according to the Rule 3.6.2.
- v) If, for any reason, a pentathlete withdraws before the end of the single pool, all their results will be disregarded, for them and for all their opponents. The point value of the victory is not changed.

3.4.17 Recognition of Results

Immediately after each match the Referee must fill in the whole score sheet and sign it. The team representative and/or the pentathletes must check the accuracy of the results and sign the score sheet presented to them by the Referee. As soon as a team



representative or pentathlete has signed the score sheet, no verbal complaint relating to the result will be allowed.

3.5 SCORING POINTS

At all UIPM competitions, all bouts in the fencing event count for the Modern Pentathlon points in both the individual and team classification, except as provided for by articles 3.4.16 v) and 3.6.2 iii) c).

3.5.1 Ranking Round

3.5.1.1 Points in Individual Competition

70% of bouts won corresponds to 250 points.
Each victory over or under this number is in accordance with the number of the bouts, as laid down by the Points table annexed to these Rules (Appendix 3B).
A pentathlete finishing the competition without a victory scores 0 (zero) MP points.

3.5.1.2 Points in Relay Competition

70% of bouts won correspond to 250 points.
Each victory over or under this number is in accordance with the number of the bouts, as laid down by the Points table annexed to these Rules (Appendices 3B2 and 3B3)

3.5.1.3 Tie

In case of a tie between the number of fencing victories, place will be determined as follows:

- i) in case of a tie between two pentathletes, the winner of the tied pentathletes' bout,
- ii) in case of a tie with more than two pentathletes, the pentathlete with the most wins in the tied pentathletes' bouts,
- iii) if there is still no outright winner, the athlete with the most PWR points is placed higher.

3.5.2 Bonus Round

Athletes/teams do not lose points if they are defeated.

3.5.2.1

Each bout winning pentathlete/team receives 2 (two) MP bonus points. The top placed pentathlete/team of the Ranking Round will receive double bonus points if they win their bout in the Fencing Bonus Round at both Semi-finals and Final groups.

3.5.2.2 Tie break / double defeat

- i) In the case of a double defeat, the winner of the bout is the pentathlete placed higher on the start list
- ii) In the case of a tie in Team Relay after 2 bouts, the pentathlete that fenced the second bout, remains on the piste and fences another bout. The first pentathlete to score a hit is the winner. In this way the athletes fight the best of three bouts. If there is still a tie after the 3rd bout, the winner is the team placed higher on the start list.
- iii) In case of a victory tie after the Fencing Ranking Round, the athletes will keep their ranking achieved in the Fencing Ranking Round after splitting into two Semi-Final groups, even the athletes in tie will be in the same Semi-Final group or won't.

3.5.2.3 Does not start/ Does not Finish

- i) If a pentathlete does not start in the Bonus round, the pentathlete on the piste will fight the next placed pentathlete.
- ii) The pentathlete that does not start or withdraws for any reason during the Bonus Round will be eliminated from the Fencing discipline, and scores zero points in fencing (RR + BR). The scores of the opponents remain unchanged for ranking round and bonus round.
- iii) If a pentathlete does not finish their bout for any reason, their opponent on the piste is considered the victor and receives the bonus point(s).

3.6 INFRINGEMENTS AND PENALTIES

3.6.1 Principles

- i) Fencers must show respect to their opponents by saluting each other, the Referee and the spectators before and after each bout. At the end of the bout and after the Referee has made their decision, the pentathletes must shake their unarmed hands. Failure to do so incurs a penalty as specified in Rule 3.6.3 v). This applies to both Ranking Round and Bonus Round.

- ii) Everybody at the fencing event must remain orderly and must not disturb the smooth running of the competition. By entering a Modern Pentathlon competition, pentathletes undertake to observe the Rules and the decisions of the Referee, to be respectful to the Fencing Director and the members of the Jury and to obey the orders and requirements of the Referee. Any breach of the Rule will be penalised according to Rules 3.6.3 i) and 3.6.3 iii).
- iii) Pentathletes must fence to their utmost ability in a sportsmanlike manner until the end of the fencing event to obtain the best possible classification, without giving away any hits or seeking to be favoured by being given a hit. Failure to do so will incur penalties according to Rule 3.6.3 ii) and 3.6.3 iv).
- iv) A pentathlete, who while fencing, commits a violent or vindictive action against an opponent, the Referee or Judges, or who does not fence to their utmost ability, or who profits from a fraudulent agreement with their opponent, may be eliminated or disqualified from the competition according to Rule 3.6.3 iv).

3.6.2

Types of Penalties

- i) Except for the loss of ground on the piste and the refusal to award a hit or the award of a hit which in fact has not been received, there are three (3) types of penalty to be applied depending on which offences have been committed. There are five groups of offences. If a Referee has to penalise a pentathlete who has committed several faults at the same time, they should penalise the least serious fault first.
- ii) The penalties are cumulative and they are valid for the match (except the fifth group). Certain offences can result in the annulment of hit scored by the pentathlete at fault. During the bout, only hits scored in circumstances connected with the offences may be annulled.
- iii) The penalties are as follows:
 - a) A warning – indicated by a **Yellow Card**, with which a Referee identifies the pentathlete at fault. The pentathlete then knows that any further offence on this part will result a more severe penalty.
 - b) A deduction of 10 Modern Pentathlon (MP) points in the Ranking Round and 1 (one) MP point in the Bonus Round indicated by a **Red Card**, with which a Referee identifies the athlete at fault. Furthermore, a Red card can only be followed by a Red card or by a Black card, depending on the nature of the second offence.
 - c) Elimination or disqualification (from the competition as applicable for a pentathlete = 0 points in the fencing event) or an exclusion (from the competition venue for any person disturbing the order of competition) – indicated by **Black Card**, with which a Referee identifies the pentathlete or person at fault.
- iv) All penalties must be shown and noted on the score sheet (protocol) of the match, together with the kind of offence having been committed by indicating one of the five groups of offences.

3.6.3

Groups of Offences (see Appendix 3A – PENALTY TABLE)

- i) **The first group of offences** is penalised by indicating a Yellow Card (warning). If during the same match the pentathlete commits the same or different offence in this group, the Referee penalises the pentathlete, in each occasion with a Red card (deduction of 10 MP points in the Ranking Round and 1 (one) MP point in the Bonus Round). If the pentathlete at fault has already been penalised by a Red Card because of an offence listed in the second or third group, they receive a further Red Card for their first infringement relating to the first group.
- ii) **The second group of offences:** in the first and any further infringement is penalised by indicating a Red Card (deduction of 10 MP points in the Ranking Round and 1 (one) MP point in the Bonus Round each).
- iii) **The third group of offences:** the first infringement is penalised by indicating a Red Card (deduction of 10 MP points in the Ranking Round and 1 (one) MP point in the Bonus Round), even if the athlete at fault has already received a



Red card as a result of offences in the first or second groups. If during the same match the pentathlete commits the same or different offence in this group, they are penalised with a Black Card (elimination or disqualification).

Any person not on the piste who disturbs the order of the competition receives:

- a) On the first infringement a warning – indicated by Yellow Card, valid for the whole competition, which must be noted on the match score sheet (protocol) and recorded by the Fencing Director and UIPM TD/NT0;
 - b) on the second infringement during the same competition day a Black Card (exclusion from the competition venue). In the most serious cases concerning disturbance either on or off the piste, the Referee may exclude or expel the person at fault immediately.
- iv) **The fourth group of offences** the first infringement is penalised by indicating a Black Card (elimination, disqualification or exclusion).
- v) **The fifth group of offences**, the first infringement is penalised by indicating a Red Card (deduction of 10 MP points in the Ranking Round and 1 (one) MP point in the Bonus Round). In the case refusing the salute or handshake as specified in Rule 3.6.1:
- a) the first infringement will be penalised by indicating a Red Card (deduction of 10 MP points in the Ranking Round and 1 (one) MP point in the Bonus Round) and must be noted on the match score sheet (protocol) and recorded by the Fencing Director and UIPM TD/NT0;
 - b) in the second infringements will be penalised by indicating a Black Card – elimination.

PENALTY TABLE

FENCING

APPENDIX 3A

FIRST GROUP – OFFENCE (valid for the match)	Article	1 st Offence	2 nd Offence	3 rd & Subsequent
(valid for the match)	3.4.2 iii 3.6.3 i	Yellow Card	Red Card	Red Card
Clothing/equipment not conforming, absence of second regulation weapon or body wire	3.4.2 iii 3.6.3 i			
Fencer not presenting at the first call of the Referee	3.4.4 iii) 3.6.3 i)			
Removal of mask before the Referee calls "Halt"	3.4.4 iii) 3.6.3 i)			
Leaving piste without permission	3.4.4 ix) 3.6.3 i)			
Improperly causing or prolonging interrup- tions of bout	3.4.4 xi) 3.6.3 i)			
Bending, dragging weapon point on conductive piste, straightening weapon on conductive piste	3.4.5 vi) vii) 3.6.3 i)			
Flèche attack resulting in shock that jostles the opponent (*)	3.4.7 ii) 3.6.3 i)			
Jostling, disorderly fencing, irregular move- ments, hits made by violence, hits with guard, abuse of mask equipment (*)	3.4.7 iii) 3.6.3 i)			
Turning back on opponent (*)	3.4.7 vi) 3.4.7 ix) 3.6.3 i) or 3.6.3 ii)			
Touching, taking hold of electrical equip- ment	3.4.9 ii) 3.6.3 i)			
Corps a corps to avoid being hit (*)	3.4.10 ii) 3.6.3 i)			
Leaving piste to avoid being hit	3.4.7 vi) 3.6.3 i)			
Refusal to obey the Referee	3.4.7 iv) 3.4.11 iii) 3.6.3 i)			
Unjustified appeal	3.4.4 iii) 3.6.3 i)			

SECOND GROUP – OFFENCE	Article	1 st Offence	2 nd Offence	3 rd & Subsequent
Interruption of bout by claimed injury not confirmed by Doctor on duty	3.4.16 iv)	Red Card	Red Card	Red Card
Absence of weapon check marks (*)	3.4.2 iv)			
Incorrect grip or incorrect holding of épée	3.4.6 iii)			
Use a non-sword hand / arm (*)	3.4.10 i) 3.6.3 ii)			
Deliberate hit not on opponent (*)	3.4.14 i d)			
Dangerous, violent or vindictive action, blow with guard or pommel or mask	3.4.7 ix)			



THIRD GROUP – OFFENCE (valid for the competition)	Article	1 st Offence	2 nd Offence
Faking weapon check marks, intentional modification of equipment (*)	3.4.2	Red card RR 10 pts / BR 1pt	Disquali- fication
Athlete disturbing order when on piste	3.6.3 ii		
Not wearing or wearing defected protec- tive under-plastron	3.4.2 iii) e)	Elimination (1)	
Non presentation when called by the Ref- eree at the start of the competition after three calls at one minute intervals	3.4.4 ii) 3.6.3 ii		
Any person not on piste disturbing good order	3.6.1 iii	Yellow (4)	Exclusion (3)

FOURTH GROUP – OFFENCE	Article	1 st Offence	2 nd Offence
Manifest cheating with equipment	3.4.2		Disqualification (2)
Offence against sportsmanship, profiting from collusion, favouring an opponent	3.6.1 iii		
Deliberate brutality	3.6.1 iv		
Dishonest fencing (*)	3.6.1 ii		
Fencer equipped with electronic commu- nication equipment permitting receipt of communications during the bout	3.4.2 v) c)		

FIFTH GROUP – OFFENCE	Article	1 st Offence	2 nd Offence
Not wearing an armet in the national colours	3.7.2 iv)	Red Card RR 10 pts / BR 1pt	---
Not wearing his/her surname and National code letters	3.7.2 iii)		
Missing or bad placing of the UIPM logo patch	3.7.2 v)		
Refusing to salute or shake hands	3.6.1 i)		Black Card (1)

Penalty Tables Comments:

- (*) - Annulment of any hit scored by pentathlete at fault
- Yellow Card – warning, valid for match
- Red Card – Deduction of 10 MP points in Ranking Round (RR) or 1 MP point in Bonus Round (BR)
- Black Card – Elimination, disqualification or exclusion

- 1) Elimination from the event
- 2) Disqualification from the competition or in severe cases from Championships
- 3) Exclusion = Disqualification from the competition or in severe cases from Championships
- 4) In serious cases, the Referee may exclude immediately

POINTS TABLE

Formula: 70% bouts won correspond to 250 MP points
Each victory over or below this number is in accordance with the number of bouts

FENCING

Example:

APPENDIX 3B1

1.INDIVIDUAL

36 pentathletes take part = 35 bouts
70% of bouts = 25 victories = **250** MP points \pm 1 victory = \pm 5 points

The figures:

- left column = the number of victories for **250** MP points -
- centre column = number of bouts
- right column = the points value of 1 victory

250	bouts	Value of V
42	60	3
41	59	3
41	58	3
40	57	3
39	56	3
39	55	3
38	54	3
37	53	3
36	52	3
36	51	3
35	50	3
34	49	3
34	48	3

250	bouts	Value of V
33	47	4
32	46	4
32	45	4
31	44	4
30	43	4
29	42	4
29	41	4
28	40	4

250	bouts	Value of V
27	39	5
27	38	5
26	37	5
25	36	5
25	35	5
24	34	5
23	33	6
22	32	6
22	31	6
21	30	6

250	bouts	Value of V
20	29	7
20	28	7
19	27	7
18	26	7
18	25	7
17	24	7
16	23	7
15	22	8
15	21	8
14	20	8
13	19	8



2. RELAY

Example:

14 teams take part = 26 bouts
 70% of bouts = 18 victories = 250 MP points
 points
 ± 1 victory = ± 7 points

Example:

24 teams take part = 46 bouts
 70% of bouts = 32 victories = 250
 points
 1 victory = ± 4 points

teams	rounds	bouts/ athlete/ round	total bouts/ athlete	total bouts/ team	250 points = victories	value of victory
5	4	4	16	32	22	6
6	5	4	20	40	28	4
7	6	3	18	36	25	5
8	7	3	21	42	29	4
9	8	2	16	32	22	6
10	9	2	18	36	25	5
11	10	2	20	40	28	4
12	11	2	22	44	31	4
13	12	2	24	48	34	3
14	13	1	13	26	18	7
15	14	1	14	28	20	7
16	15	1	15	30	21	6
17	16	1	16	32	22	6
18	17	1	17	34	24	5
19	18	1	18	36	25	5
20	19	1	19	38	27	5
21	20	1	20	40	28	4
22	21	1	21	42	29	4
23	22	1	22	44	31	4
24	23	1	23	46	32	4

**TEAMS CIRCULATION
TABLE**

If there is an even number of teams, all teams are fencing in every round.
Team number 1 stays always at piste A.
Example: 36 pentathletes = 18 teams = 17 rounds

FENCING

Appendix 3C

Piste									
Rounds	A	B	C	D	E	F	G	H	I
0 + 1	1 - 18	2 - 17	3 - 16	4 - 15	5 - 14	6 - 13	7 - 12	8 - 11	9 - 10
2	1 - 17	18 - 16	2 - 15	3 - 14	4 - 13	5 - 12	6 - 11	7 - 10	8 - 9
3	1 - 16	17 - 15	18 - 14	2 - 13	3 - 12	4 - 11	5 - 10	6 - 9	7 - 8
4	1 - 15	16 - 14	17 - 13	18 - 12	2 - 11	3 - 10	4 - 9	5 - 8	6 - 7
5	1 - 14	15 - 13	16 - 12	17 - 11	18 - 10	2 - 9	3 - 8	4 - 7	5 - 6
6	1 - 13	14 - 12	15 - 11	16 - 10	17 - 9	18 - 8	2 - 7	3 - 6	4 - 5
7	1 - 12	13 - 11	14 - 10	15 - 9	16 - 8	17 - 7	18 - 6	2 - 5	3 - 4
8	1 - 11	12 - 10	13 - 9	14 - 8	15 - 7	16 - 6	17 - 5	18 - 4	2 - 3
9	1 - 10	11 - 9	12 - 8	13 - 7	14 - 6	15 - 5	16 - 4	17 - 3	18 - 2
10	1 - 9	10 - 8	11 - 7	12 - 6	13 - 5	14 - 4	15 - 3	16 - 2	17 - 18
11	1 - 8	9 - 7	10 - 6	11 - 5	12 - 4	13 - 3	14 - 2	15 - 18	16 - 17
12	1 - 7	8 - 6	9 - 5	10 - 4	11 - 3	12 - 2	13 - 18	14 - 17	15 - 16
13	1 - 6	7 - 5	8 - 4	9 - 3	10 - 2	11 - 18	12 - 17	13 - 16	14 - 15
14	1 - 5	6 - 4	7 - 3	8 - 2	9 - 18	10 - 17	11 - 16	12 - 15	13 - 14
15	1 - 4	5 - 3	6 - 2	7 - 18	8 - 17	9 - 16	10 - 15	11 - 14	12 - 13
16	1 - 3	4 - 2	5 - 18	6 - 17	7 - 16	8 - 15	9 - 14	10 - 13	11 - 12
17	1 - 2	3 - 18	4 - 17	5 - 16	6 - 15	7 - 14	8 - 13	9 - 12	10 - 11

If there is an odd number of teams (for example 17), one of the teams rests in every round.

Piste									
Rounds	A	B	C	D	E	F	G	H	Rest
0 + 1	1 - 17	2 - 16	3 - 15	4 - 14	5 - 13	6 - 12	7 - 11	8 - 10	9
2	17 - 16	1 - 15	2 - 14	3 - 13	4 - 12	5 - 11	6 - 10	7 - 9	8
3	16 - 15	17 - 14	1 - 13	2 - 12	3 - 11	4 - 10	5 - 9	6 - 8	7
4	15 - 14	16 - 13	17 - 12	1 - 11	2 - 10	3 - 9	4 - 8	5 - 7	6
5	etc.								
etc.									
16	3 - 2	4 - 1	5 - 17	6 - 16	7 - 15	8 - 14	9 - 13	10 - 12	11
17	2 - 1	3 - 17	4 - 16	5 - 15	6 - 14	7 - 13	8 - 12	9 - 11	10

**National Federations
with two or more
teams:**

When the LOC (or a nation) has two or more teams taking part in the competition, the teams will meet in the first rounds of the fencing event in accordance with following prescribed order:

Principle	Number of Teams in Competition		
	16	17	18
Host team "A" - is always number 2	2	2	2
Host team "B" - is always number last but one	15	16	17
Host team "C" - is always number 4th from the end	13	14	15
Host team "D" - is always number 6th from the end	11	12	13
NF X: team "A" is always number 3	3	3	3
team "B" is always 3rd from the end	14	15	16
NF Y: team "A" is always number 8	8	8	8
team "B" is the nearest to number 8 in the first round	9	10	11

The numbers given to individual teams in this way are not included into the drawing of the lots.

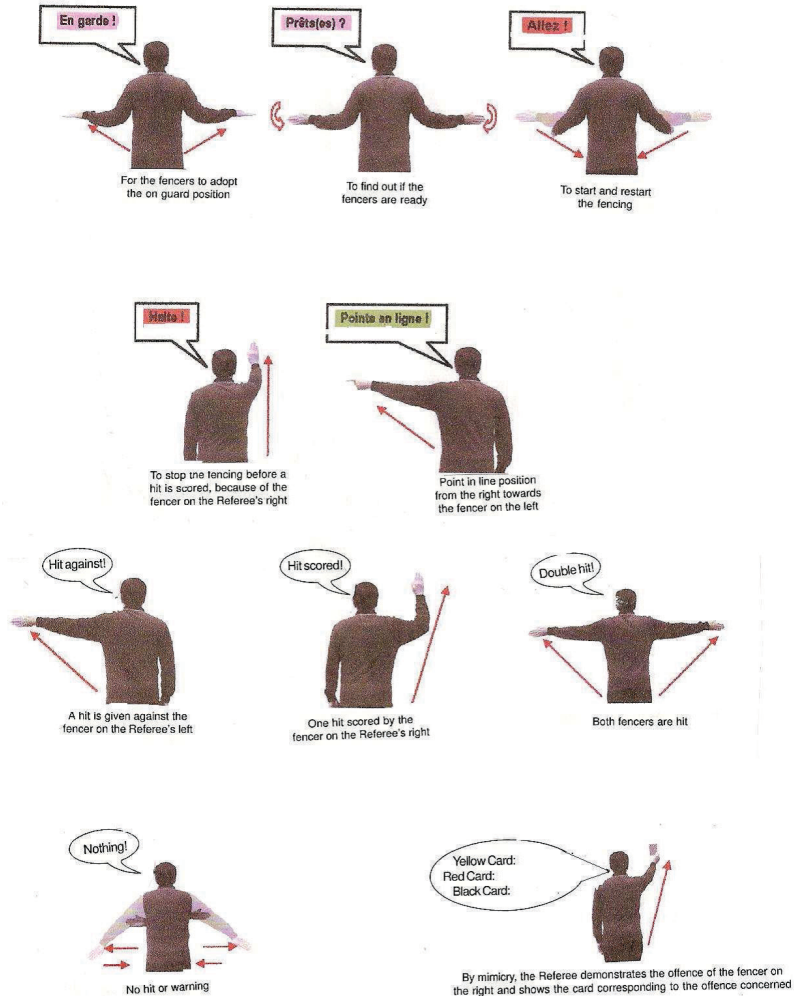

NOTES

1. The Referee analyses the fencing and announces his decisions by means of the signals and words above.
2. In following the fencing phrase the Referee uses the following words without making the signals: "Riposte!", "Counter-riposte!", "Remise!", "Reprise!", "Redouble!"
3. The fencers may politely ask the Referee for a more complete analysis of the fencing phrase.
4. Each signal must last 1-2 seconds, be expressive and be correctly made. Above they refer to the fencer on the Referee's right.

Figure 3. Referee signals and commands



SWIMMING

PART A

THE EVENT

4.1 PRESENTATION OF THE EVENT

1 The Swimming Event

2 Distances

4.2 AUTHORITIES

1 The Swimming Director
2 The Referee
3 The Starter
4 The Chief Inspector of Turns
5 The Inspectors of Turns

6 The Clerk of Course
7 The Arrival Judges
8 The Chief Timekeeper
9 The Timekeepers
10 The Announcer

4.3 ORGANISATION AND SCHEDULE OF THE EVENT

1 Heats and Lanes
2 Pool open

3 Control in the Call Room

4.4 CONDUCT OF THE COMPETITION - JUDGEMENT OF THE PERFORMANCE

1 The Start

2 The Finish

4.5 SCORING OF POINTS

1 Recording of Times

2 Calculation of Points

4.6 INFRINGEMENTS AND PENALTIES

1 10 points Deduction
2 Elimination

3 Disqualification

PART A

Appendix 4A

Appendix 4B1

Appendix 4B2

Appendix 4B3

Appendix 4B4

THE EVENT

DISTANCES AND POINTS TABLE

PENALTY TABLE

POINTS TABLE – Individual 200m – Relay 2x100m

POINTS TABLE – Individual 100m – Relay 2x50m

POINTS TABLE – Individual 50m – Relay 2x25m



4

EVENT RULES – SWIMMING

PART A

THE EVENT

4.1 PRESENTATION OF THE EVENT

4.1.1 The Swimming Event

The Swimming event is a free-style event. Pentathletes may swim and change any stroke or style. At the turning and at the finish, the pentathlete must touch the end of the pool with some part of his body.

4.1.2 The Distances

Age	Individual	Relay
Senior, Junior Under 19, Under 17	200 m	2 x 100m
Under 15, Under 13	100 m	2 x 50 m
Under 11, Under 9	50 m	2 x 25 m

4.2 AUTHORITIES

At all official UIPM competitions there must be a Swimming Director, a Referee, a Starter, a False Start Auxiliary, a Chief Inspector of Turns, Inspectors of Turns, Arrival Judges, Clerks of the Course, a Chief Timekeeper, Timekeepers and an Announcer. Upon a question of fact, a decision by the relevant official is final.

4.2.1 The Swimming Director

- i) appoints all the afore-mentioned officials and is responsible for managing and coordinating the activities of all the officials appointed.
- ii) decides on any verbal complaints received from pentathletes/team representatives relating to the event in progress.

4.2.2 The Referee

- i) holds the responsibility for the enforcement of the UIPM Competition Rules and may intervene in the event at any stage to ensure the observance of all UIPM Rules.
- ii) determines placing by consultation with the automatic officiating equipment, if available and operating. If no automatic officiating equipment is used, he/ she determines placing when the decision of the Arrival Judges at the finish and the times recorded do not agree.
- iii) at the beginning of each heat, signals to the pentathletes by a series of short whistles that they are invited to remove all clothing except for swim wear, and then by a long whistle thereafter that they must take their positions on the starting block.
- iv) when the pentathletes and officials are ready to start, indicates to the Starter with a stretched-out arm that the pentathletes are now under the Starter's control.
- v) gives the "clear watches" signal to the time keepers after all the data from the previous heat are collected.

4.2.3 The Starter

- i) has full control of the pentathletes from the time the Referee turns the pentathletes over to him.
- ii) reports a pentathlete to the Referee for delaying the start, for wilfully disobeying an order or for any other misconduct taking place at the start.
- iii) has power to decide whether the start is fair, subject only to the control of the

- Referee. Once the start signal has been given the Starter must not change his opinion and must not recall the pentathletes.
- iv) must stand on the side of the pool within approximately five (5) meters of the starting end so that the Timekeepers can see and the pentathletes hear the start signal.
- 4.2.4
The Chief Inspector of Turns**
- i) ensures that the Inspectors of turns fulfil their duties during the event.
ii) receives their reports if any infringement has occurred and presents the reports to the Referee immediately.
- 4.2.5
The Inspectors of Turns**
- i) shall be assigned for two lanes at the far end of the pool and ensures that the pentathletes comply with the relevant rules for turning.
ii) reports any violation to the Chief Inspector of turns.
- 4.2.6
The Clerk of Course**
- i) assembles the pentathletes prior to each heat.
ii) check swimsuits, refusing any pentathlete with nonconforming swimwear to go to the start.
iii) will refuse any pentathlete who has used oil or another fat solution on their bodies to go to the start.
iv) is responsible for ensuring that the pentathletes are ready for the Starter prior to each heat.
- 4.2.7** The **Arrival Judges** register the order of arrival of the pentathletes.
- 4.2.8
The Chief Timekeeper**
- i) assigns the positions of all the Timekeepers at the starting end of the pool and assigns the lanes for which they are responsible.
ii) designates two additional Timekeepers, either of whom must be directed to replace any Timekeeper whose watch did not start or stopped during the event, or for any other reason is not able to record the time.
iii) collects from each Timekeeper a card showing the time recorded and, if necessary, inspects their watches.
iv) examines and records the official time on the card for each lane.
- 4.2.9** There must be at least two **Timekeepers** appointed for each lane in all official UIPM competitions. It is Timekeepers' responsibility to:
- i) take the time of the pentathletes in their lane.
ii) start their watches at the start signal and stop it when the pentathletes in their lane touch the end of the pool, having completed the race.
iii) record the times of their watches on the card for their lane and, if requested, present their watches for inspection.
iv) must not clear their watches until they have received the "clear watches" signal.
v) act as Inspector of Turns at their end of the pool.
- 4.2.10** The **Announcer** keeps the pentathletes and spectators informed about the course of the event. In particular, the Announcer presents the athletes before each heat, broadcasts the swimming times of the pentathletes from the previous heat, announces any false starts and after the last heat, declares the results after two events.
- 4.3
ORGANISATION AND SCHEDULE OF EVENTS**
- 4.3.1
Heats and Lanes**
- i) The pentathletes or teams will be placed according to their PWR swimming time. In Semi-finals or Finals of Pentathlon and Tetrathlon competitions, athletes or relay teams will be placed in heats according to their total results after the previous event(s), with athletes and teams with higher scores swimming in the last heat. Athletes swimming in the same heat will be seeded with the athlete with more Pentathlon points in lane 1, and so on.



- ii) If the pentathlete is not in a PWR, the heats for Swimming in the Qualification will be composed based on the swimming times on the entries.
- iii) The TD/NTO can authorise an entry time in case of absence of coach.
- iv) In the Qualification athletes will swim according to their PWR swimming time. In each heat the pentathlete with the best time will swim in the centre lane of the pool.
- v) The number of pentathletes in each heat must remain as equal as possible, with the later heat(s) containing more athletes if need be.
- vi) The LOC must indicate at the Technical Meeting how many swimmers will be in each heat and which lanes, if any will not be used.
- vii) In a pool with an even number of 6, 8 or 10 lanes, the central lane will be 3, 4 or 5. The pentathlete having the next fastest swim time is to be placed on his left in the Qualification, then alternating the others right and left in descending order by their swimming times.
- viii) The athletes are assembled by heats in the Call Chamber and then conducted in a parade to the starting line, beside the starting blocks. In this place they are presented individually (at least lane, name and nation) by the Announcer, starting at lane 1.

4.3.2

Pool open

In the Qualifications the pool must be open for warm up minimum 20 minutes. Exact times are announced by LOC. The pool will be closed 10 minutes before competition start time for athletes to go to the call room. In the Semi-finals and Finals of the Pentathlon and Tetrathlon events the pool must be open 60 minutes prior to the start of the first athlete in the first discipline of the competition.

4.3.3

Control in the Call Room

Pentathletes with nonconforming swimwear will not be authorised to compete unless they change to appropriate swimwear before the start of the presentation. Disqualification will be applied if a pentathlete refuses to comply with this rule. Pentathletes with oil or grease on the body will be disqualified immediately.

4.4

CONDUCT OF THE COMPETITION / JUDGEMENT OF THE PERFORMANCE

4.4.1

The Start

- i) The start begins with a dive. On the long whistle from the Referee the pentathletes must step on the starting block and remain there. On the Starter's command "Take your Marks" the pentathletes must immediately take up a starting position with at least one foot at the front of the starting block. When all competitors are stationary, the Starter gives the start signal by using a start pistol, horn, whistle or command.
- ii) In the case of a false start, the responsible pentathlete will be penalised and it will be announced during the course of the heat which pentathlete or team will be penalised. Such a false start is given
 - a) if a pentathlete jumps or falls into the water before the command "Take your Marks".
 - b) if after the command "Take your Marks" any pentathlete jumps or falls into the water before the start signal; In this case the false start rope will be used.
 - c) if a pentathlete begins their start movements prior to the start signal.
- iii) A pentathlete that is injured may start in the water holding the rail of the pool. A pentathlete whom, in the opinion of the referee, has been fouled in such a way that they have been impeded, must be allowed to swim again after an appropriate period of rest.

4.4.2

Some part of the swimmer must break the surface of the water throughout the race, except it shall be permissible for the swimmer to be completely submerged during the turn and for a distance of not more than 15 metres after the start and each turn. By that point, the head must have broken the surface.

4.4.3**The Finish**

After finishing, the pentathlete must stay in the water, in the assigned lane, until the Referee has given permission to leave the water by using a whistle and hand sign.

- i) The pentathlete is not allowed to leave the water by the front side.
- ii) The pentathlete is not allowed to leave the swimming line before the Referee's command.
- iii) As soon as the last heat is over, the Referee blows the whistle and the pentathletes must exit the pool. The Referee can then confirm that the competition is finished and gives permission for the pool to be open to all pentathletes.

4.5**SCORING OF POINTS**

Points and positions are decided by actual time. At Category A official UIPM competitions an electrical timing device registering 1/100 seconds is compulsory.

4.5.1**Recording of Times**

- i) When automatic judging and timing equipment approved by FINA is provided, it must be used to determine the winner, placing and times for each lane. The results and time so determined have precedence over the decisions of the Timekeepers.
- ii) In the case of a breakdown or mechanical failure of the Automatic Officiating Equipment, the Timekeepers' decisions will take precedence and reference must be made to all manual times recorded in that particular heat.
- iii) When two timekeepers are used for a lane and the times recorded do not agree, then the average time of the two recorded times will be taken. When only one timekeeper is used per lane then his recorded time is to be the accepted time.

4.5.2**Calculation of Points**

For the purpose of calculating the score, times will be recorded:

02:30.00 – .49 = 250 points

02:30.50 – .99 = 249 points

02:31.00 – .49 = 248 points.

4.6**INFRINGEMENTS AND PENALTIES****4.6.1**

A pentathlete or team is penalised by deduction of 10 points for:

- i) taking a step on the bottom of the pool.
- ii) not touching the end of the pool with some part of the body when turning.
- iii) leaving the swimming lane before the command to leave the lane.
- iv) leaving the water by the front side.
- v) after the last heat is over, entering the water without waiting for the Referee's permission.
- vi) beginning of start movements prior to start signal or jumping or falling into the water after the command "Take your marks" and before the start signal.
- vii) Missing or bad placing of the UIPM logo patch.

4.6.2

A pentathlete or team is eliminated for:

- i) for not breaking the surface after 15m.
- ii) delaying a start, wilfully disobeying an order or for any other misconduct taking place at the start; jumping or falling into the water before the command "Take your Marks".
- iii) using any other device that may aid the pentathlete's speed, buoyancy or endurance during the swim, such as webbed gloves, flippers and fins.
- iv) incorrect change over in the Relay

4.6.3

A pentathlete is disqualified and their team eliminated for:

- i) wilfully, and with intent, pushing, swimming across or obstructing another pentathlete so as to impede their progress or to intentionally gain an early start.
- ii) using oil or grease.
- iii) refusing to wear conforming swimwear.



PART D

ANNEXES

PENALTY TABLE

SWIMMING

Appendix 4A

The pentathlete infringes the rules and is penalised for:	Article	Penalty
taking a step on the bottom of the pool	4.6.1 i)	Deduction of 10 Modern Pentathlon points
failure to touch the end of the pool when turning	4.2.6 ii)	
leaving the lane or the water before command	4.4.3 iii)	
leaving the water by the front side	4.4.2 i) 4.6.1 iv)	
after the last heat is over, entering the water without waiting for the Referee's permission	4.6.1 v)	
beginning of start movements prior to start signal or jumping or falling into the water after the command "Take your marks" and before the start signal	4.6.1 vi)	
missing or bad placing of the UIPM logo patch	4.6.1 vii)	Elimination
Swimming more than 15m underwater without breaking the surface	4.6.2 i)	
delaying a start, wilfully disobeying an order or for any other misconduct taking place at the start	4.2.3 ii) 4.6.2 ii)	
jumping or falling into the water before the command "Take your Marks";	4.4.1ii) 4.6.2 iii)	
incorrect change over in the Relay	4.6.2 v)	
using devices that may aid his speed, buoyancy or endurance (webbed gloves, flippers, fins, tapes etc.)	4.6.2 iv) See also MP EQP Regulations	
wilfully, and with intent, pushing, swimming across or obstructing another pentathlete to impede his progress	4.6.3 i)	Disqualification Elimination of the team
using oil or grease;	4.6.3 ii)	
refusing to wear conforming swimwear;	4.6.3 iii, 4.7	

DISTANCES AND POINTS TABLE

Appendix 4B1

(Note: for explanation and application, please refer to Chapter 3.6)

Age	Individual	Relay	250 pts	Each 0.50sec
Senior, Junior Under 19, Under 17	200 m	2 x 100m	2:30.00	+/- 1 point
Under 15, Under 13	100 m	2 x 50 m	1:20.00	+/- 1 point
Under 11, Under 9	50 m	2 x 25 m	0:45.00	+/- 1 point

POINTS TABLE
SWIMMING: 200m and 2 x 100m
Appendix 4B2

Men and Women Individual: Seniors, Juniors, Under 19 & 17
Relay: Seniors, Juniors, Under 19 & 17

time	pts	time	pts	time	pts	time	pts	time	pts	time	pts	time	pts	time	pts
1.39.00	352	2.01.50	307	2.24.00	262	2.46.50	217	3.09.00	172	3.31.50	127	3.54.00	82	4.16.50	37
1.39.50	351	2.02.00	306	2.24.50	261	2.47.00	216	3.09.50	171	3.32.00	126	3.54.50	81	4.17.00	36
<u>1.40.00</u>	350	2.02.50	305	<u>2.25.00</u>	260	2.47.50	215	<u>3.10.00</u>	170	3.32.50	125	<u>3.55.00</u>	80	4.17.50	35
1.40.50	349	2.03.00	304	2.25.50	259	2.48.00	214	3.10.50	169	3.33.00	124	3.55.50	79	4.18.00	34
1.41.00	348	2.03.50	303	2.26.00	258	2.48.50	213	3.11.00	168	3.33.50	123	3.56.00	78	4.18.50	33
1.41.50	347	2.04.00	302	2.26.50	257	2.49.00	212	3.11.50	167	3.34.00	122	3.56.50	77	4.19.00	32
1.42.00	346	2.04.50	301	2.27.00	256	2.49.50	211	3.12.00	166	3.34.50	121	3.57.00	76	4.19.50	31
1.42.50	345	<u>2.05.00</u>	300	2.27.50	255	<u>2.50.00</u>	210	3.12.50	165	<u>3.35.00</u>	120	3.57.50	75	<u>4.20.00</u>	30
1.43.00	344	2.05.50	299	2.28.00	254	2.50.50	209	3.13.00	164	3.35.50	119	3.58.00	74	4.20.50	29
1.43.50	343	2.06.00	298	2.28.50	253	2.51.00	208	3.13.50	163	3.36.00	118	3.58.50	73	4.21.00	28
1.44.00	342	2.06.50	297	2.29.00	252	2.51.50	207	3.14.00	162	3.36.50	117	3.59.00	72	4.21.50	27
1.44.50	341	2.07.00	296	2.29.50	251	2.52.00	206	3.14.50	161	3.37.00	116	3.59.50	71	4.22.00	26
<u>1.45.00</u>	340	2.07.50	295	<u>2.30.00</u>	250	2.52.50	205	<u>3.15.00</u>	160	3.37.50	115	<u>4.00.00</u>	70	4.22.50	25
1.45.50	339	2.08.00	294	2.30.50	249	2.53.00	204	3.15.50	159	3.38.00	114	4.00.50	69	4.23.00	24
1.46.00	338	2.08.50	293	2.31.00	248	2.53.50	203	3.16.00	158	3.38.50	113	4.01.00	68	4.23.50	23
1.46.50	337	2.09.00	292	2.31.50	247	2.54.00	202	3.16.50	157	3.39.00	112	4.01.50	67	4.24.00	22
1.47.00	336	2.09.50	291	2.32.00	246	2.54.50	201	3.17.00	156	3.39.50	111	4.02.00	66	4.24.50	21
1.47.50	335	<u>2.10.00</u>	290	2.32.50	245	<u>2.55.00</u>	200	3.17.50	155	<u>3.40.00</u>	110	4.02.50	65	<u>4.25.00</u>	20
1.48.00	334	2.10.50	289	2.33.00	244	2.55.50	199	3.18.00	154	3.40.50	109	4.03.00	64	4.25.50	19
1.48.50	333	2.11.00	288	2.33.50	243	2.56.00	198	3.18.50	153	3.41.00	108	4.03.50	63	4.26.00	18
1.49.00	332	2.11.50	287	2.34.00	242	2.56.50	197	3.19.00	152	3.41.50	107	4.04.00	62	4.26.50	17
1.49.50	331	2.12.00	286	2.34.50	241	2.57.00	196	3.19.50	151	3.42.00	106	4.04.50	61	4.27.00	16
<u>1.50.00</u>	330	2.12.50	285	<u>2.35.00</u>	240	2.57.50	195	<u>3.20.00</u>	150	3.42.50	105	<u>4.05.00</u>	60	4.27.50	15
1.50.50	329	2.13.00	284	2.35.50	239	2.58.00	194	3.20.50	149	3.43.00	104	4.05.50	59	4.28.00	14
1.51.00	328	2.13.50	283	2.36.00	238	2.58.50	193	3.21.00	148	3.43.50	103	4.06.00	58	4.28.50	13
1.51.50	327	2.14.00	282	2.36.50	237	2.59.00	192	3.21.50	147	3.44.00	102	4.06.50	57	4.29.00	12
1.52.00	326	2.14.50	281	2.37.00	236	2.59.50	191	3.22.00	146	3.44.50	101	4.07.00	56	4.29.50	11
1.52.50	325	<u>2.15.00</u>	280	2.37.50	235	<u>3.00.00</u>	190	3.22.50	145	<u>3.45.00</u>	100	4.07.50	55	<u>4.30.00</u>	10
1.53.00	324	2.15.50	279	2.38.00	234	3.00.50	189	3.23.00	144	3.45.50	99	4.08.00	54	4.30.50	9
1.53.50	323	2.16.00	278	2.38.50	233	3.01.00	188	3.23.50	143	3.46.00	98	4.08.50	53	4.31.00	8
1.54.00	322	2.16.50	277	2.39.00	232	3.01.50	187	3.24.00	142	3.46.50	97	4.09.00	52	4.31.50	7
1.54.50	321	2.17.00	276	2.39.50	231	3.02.00	186	3.24.50	141	3.47.00	96	4.09.50	51	4.32.00	6
<u>1.55.00</u>	320	2.17.50	275	<u>2.40.00</u>	230	3.02.50	185	<u>3.25.00</u>	140	3.47.50	95	<u>4.10.00</u>	50	4.32.50	5
1.55.50	319	2.18.00	274	2.40.50	229	3.03.00	184	3.25.50	139	3.48.00	94	4.10.50	49	4.33.00	4
1.56.00	318	2.18.50	273	2.41.00	228	3.03.50	183	3.26.00	138	3.48.50	93	4.11.00	48	4.33.50	3
1.56.50	317	2.19.00	272	2.41.50	227	3.04.00	182	3.26.50	137	3.49.00	92	4.11.50	47	4.34.00	2
1.57.00	316	2.19.50	271	2.42.00	226	3.04.50	181	3.27.00	136	3.49.50	91	4.12.00	46	4.34.50	1
1.57.50	315	<u>2.20.00</u>	270	2.42.50	225	<u>3.05.00</u>	180	3.27.50	135	<u>3.50.00</u>	90	4.12.50	45	<u>4.35.00</u>	0
1.58.00	314	2.20.50	269	2.43.00	224	3.05.50	179	3.28.00	134	3.50.50	89	4.13.00	44		
1.58.50	313	2.21.00	268	2.43.50	223	3.06.00	178	3.28.50	133	3.51.00	88	4.13.50	43		
1.59.00	312	2.21.50	267	2.44.00	222	3.06.50	177	3.29.00	132	3.51.50	87	4.14.00	42		
1.59.50	311	2.22.00	266	2.44.50	221	3.07.00	176	3.29.50	131	3.52.00	86	4.14.50	41		
<u>2.00.00</u>	310	2.22.50	265	<u>2.45.00</u>	220	3.07.50	175	<u>3.30.00</u>	130	3.52.50	85	<u>4.15.00</u>	40		
2.00.50	309	2.23.00	264	2.45.50	219	3.08.00	174	3.30.50	129	3.53.00	84	4.15.50	39		
2.01.00	308	2.23.50	263	2.46.00	218	3.08.50	173	3.31.00	128	3.53.50	83	4.16.00	38		



POINTS TABLE
SWIMMING: 100m and 2 x 50m
Appendix 4B3

Individual Boys and Girls Under 15 & 13
Relay Under 15 & 13

time	pts	time	pts	time	pts	time	pts	time	pts	time	pts	time	pts	time	pts
0.46.00	318	1.08.50	273	1.31.00	228	1.53.50	183	2.16.00	138	2.38.50	93	3.01.00	48	3.23.50	3
0.46.50	317	1.09.00	272	1.31.50	227	1.54.00	182	2.16.50	137	2.39.00	92	3.01.50	47	3.24.00	2
0.47.00	316	1.09.50	271	1.32.00	226	1.54.50	181	2.17.00	136	2.39.50	91	3.02.00	46	3.24.50	1
0.47.50	315	<u>1.10.00</u>	270	1.32.50	225	<u>1.55.00</u>	180	2.17.50	135	2.40.00	90	3.02.50	45	<u>3.25.00</u>	0
0.48.00	314	1.10.50	269	1.33.00	224	1.55.50	179	2.18.00	134	2.40.50	89	3.03.00	44		
0.48.50	313	1.11.00	268	1.33.50	223	1.56.00	178	2.18.50	133	2.41.00	88	3.03.50	43		
0.49.00	312	1.11.50	267	1.34.00	222	1.56.50	177	2.19.00	132	2.41.50	87	3.04.00	42		
0.49.50	311	1.12.00	266	1.34.50	221	1.57.00	176	2.19.50	131	2.42.00	86	3.04.50	41		
<u>0.50.00</u>	310	1.12.50	265	<u>1.35.00</u>	220	1.57.50	175	<u>2.20.00</u>	130	2.42.50	85	<u>3.05.00</u>	40		
0.50.50	309	1.13.00	264	1.35.50	219	1.58.00	174	2.20.50	129	2.43.00	84	3.05.50	39		
0.51.00	308	1.13.50	263	1.36.00	218	1.58.50	173	2.21.00	128	2.43.50	83	3.06.00	38		
0.51.50	307	1.14.00	262	1.36.50	217	1.59.00	172	2.21.50	127	2.44.00	82	3.06.50	37		
0.52.00	306	1.14.50	261	1.37.00	216	1.59.50	171	2.22.00	126	2.44.50	81	3.07.00	36		
0.52.50	305	<u>1.15.00</u>	260	1.37.50	215	<u>2.00.00</u>	170	2.22.50	125	<u>2.45.00</u>	80	3.07.50	35		
0.53.00	304	1.15.50	259	1.38.00	214	2.00.50	169	2.23.00	124	2.45.50	79	3.08.00	34		
0.53.50	303	1.16.00	258	1.38.50	213	2.01.00	168	2.23.50	123	2.46.00	78	3.08.50	33		
0.54.00	302	1.16.50	257	1.39.00	212	2.01.50	167	2.24.00	122	2.46.50	77	3.09.00	32		
0.54.50	301	1.17.00	256	1.39.50	211	2.02.00	166	2.24.50	121	2.47.00	76	3.09.50	31		
<u>0.55.00</u>	300	1.17.50	255	<u>1.40.00</u>	210	2.02.50	165	<u>2.25.00</u>	120	2.47.50	75	<u>3.10.00</u>	30		
0.55.50	299	1.18.00	254	1.40.50	209	2.03.00	164	2.25.50	119	2.48.00	74	3.10.50	29		
0.56.00	298	1.18.50	253	1.41.00	208	2.03.50	163	2.26.00	118	2.48.50	73	3.11.00	28		
0.56.50	297	1.19.00	252	1.41.50	207	2.04.00	162	2.26.50	117	2.49.00	72	3.11.50	27		
0.57.00	296	1.19.50	251	1.42.00	206	2.04.50	161	2.27.00	116	2.49.50	71	3.12.00	26		
0.57.50	295	<u>1.20.00</u>	250	1.42.50	205	<u>2.05.00</u>	160	2.27.50	115	<u>2.50.00</u>	70	3.12.50	25		
0.58.00	294	1.20.50	249	1.43.00	204	2.05.50	159	2.28.00	114	2.50.50	69	3.13.00	24		
0.58.50	293	1.21.00	248	1.43.50	203	2.06.00	158	2.28.50	113	2.51.00	68	3.13.50	23		
0.59.00	292	1.21.50	247	1.44.00	202	2.06.50	157	2.29.00	112	2.51.50	67	3.14.00	22		
0.59.50	291	1.22.00	246	1.44.50	201	2.07.00	156	2.29.50	111	2.52.00	66	3.14.50	21		
<u>1.00.00</u>	290	1.22.50	245	<u>1.45.00</u>	200	2.07.50	155	<u>2.30.00</u>	110	2.52.50	65	<u>3.15.00</u>	20		
1.00.50	289	1.23.00	244	1.45.50	199	2.08.00	154	2.30.50	109	2.53.00	64	3.15.50	19		
1.01.00	288	1.23.50	243	1.46.00	198	2.08.50	153	2.31.00	108	2.53.50	63	3.16.00	18		
1.01.50	287	1.24.00	242	1.46.50	197	2.09.00	152	2.31.50	107	2.54.00	62	3.16.50	17		
1.02.00	286	1.24.50	241	1.47.00	196	2.09.50	151	2.32.00	106	2.54.50	61	3.17.00	16		
1.02.50	285	<u>1.25.00</u>	240	1.47.50	195	<u>2.10.00</u>	150	2.32.50	105	<u>2.55.00</u>	60	3.17.50	15		
1.03.00	284	1.25.50	239	1.48.00	194	2.10.50	149	2.33.00	104	2.55.50	59	3.18.00	14		
1.03.50	283	1.26.00	238	1.48.50	193	2.11.00	148	2.33.50	103	2.56.00	58	3.18.50	13		
1.04.00	282	1.26.50	237	1.49.00	192	2.11.50	147	2.34.00	102	2.56.50	57	3.19.00	12		
1.04.50	281	1.27.00	236	1.49.50	191	2.12.00	146	2.34.50	101	2.57.00	56	3.19.50	11		
<u>1.05.00</u>	280	1.27.50	235	<u>1.50.00</u>	190	2.12.50	145	<u>2.35.00</u>	100	2.57.50	55	<u>3.20.00</u>	10		
1.05.50	279	1.28.00	234	1.50.50	189	2.13.00	144	2.35.50	99	2.58.00	54	3.20.50	9		
1.06.00	278	1.28.50	233	1.51.00	188	2.13.50	143	2.36.00	98	2.58.50	53	3.21.00	8		
1.06.50	277	1.29.00	232	1.51.50	187	2.14.00	142	2.36.50	97	2.59.00	52	3.21.50	7		
1.07.00	276	1.29.50	231	1.52.00	186	2.14.50	141	2.37.00	96	2.59.50	51	3.22.00	6		
1.07.50	275	<u>1.30.00</u>	230	1.52.50	185	<u>2.15.00</u>	140	2.37.50	95	<u>3.00.00</u>	50	3.22.50	5		
1.08.00	274	1.30.50	229	1.53.00	184	2.15.50	139	2.38.00	94	3.00.50	49	3.23.00	4		

POINTS TABLE
SWIMMING: 50m and 2 x 25m
Appendix 4B4

Individual, Boys and Girls Under 11 & 9
Relay Under 11 & 9

time	pts	time	pts	time	pts	time	pts	time	pts	time	pts	time	pts
0.22.50	295	<u>0.45.00</u>	250	1.07.50	205	<u>1.30.00</u>	160	1.52.50	115	<u>2.15.00</u>	70	2.37.50	25
0.23.00	294	0.45.50	249	1.08.00	204	1.30.50	159	1.53.00	114	2.15.50	69	2.38.00	24
0.23.50	293	0.46.00	248	1.08.50	203	1.31.00	158	1.53.50	113	2.16.00	68	2.38.50	23
0.24.00	292	0.46.50	247	1.09.00	202	1.31.50	157	1.54.00	112	2.16.50	67	2.39.00	22
0.24.50	291	0.47.00	246	1.09.50	201	1.32.00	156	1.54.50	111	2.17.00	66	2.39.50	21
<u>0.25.00</u>	290	0.47.50	245	<u>1.10.00</u>	200	1.32.50	155	<u>1.55.00</u>	110	2.17.50	65	<u>2.40.00</u>	20
0.25.50	289	0.48.00	244	1.10.50	199	1.33.00	154	1.55.50	109	2.18.00	64	2.40.50	19
0.26.00	288	0.48.50	243	1.11.00	198	1.33.50	153	1.56.00	108	2.18.50	63	2.41.00	18
0.26.50	287	0.49.00	242	1.11.50	197	1.34.00	152	1.56.50	107	2.19.00	62	2.41.50	17
0.27.00	286	0.49.50	241	1.12.00	196	1.34.50	151	1.57.00	106	2.19.50	61	2.42.00	16
0.27.50	285	<u>0.50.00</u>	240	1.12.50	195	<u>1.35.00</u>	150	1.57.50	105	<u>2.20.00</u>	60	2.42.50	15
0.28.00	284	0.50.50	239	1.13.00	194	1.35.50	149	1.58.00	104	2.20.50	59	2.43.00	14
0.28.50	283	0.51.00	238	1.13.50	193	1.36.00	148	1.58.50	103	2.21.00	58	2.43.50	13
0.29.00	282	0.51.50	237	1.14.00	192	1.36.50	147	1.59.00	102	2.21.50	57	2.44.00	12
0.29.50	281	0.52.00	236	1.14.50	191	1.37.00	146	1.59.50	101	2.22.00	56	2.44.50	11
<u>0.30.00</u>	280	0.52.50	235	<u>1.15.00</u>	190	1.37.50	145	<u>2.00.00</u>	100	2.22.50	55	<u>2.45.00</u>	10
0.30.50	279	0.53.00	234	1.15.50	189	1.38.00	144	2.00.50	99	2.23.00	54	2.45.50	9
0.31.00	278	0.53.50	233	1.16.00	188	1.38.50	143	2.01.00	98	2.23.50	53	2.46.00	8
0.31.50	277	0.54.00	232	1.16.50	187	1.39.00	142	2.01.50	97	2.24.00	52	2.46.50	7
0.32.00	276	0.54.50	231	1.17.00	186	1.39.50	141	2.02.00	96	2.24.50	51	2.47.00	6
0.32.50	275	<u>0.55.00</u>	230	1.17.50	185	<u>1.40.00</u>	140	2.02.50	95	<u>2.25.00</u>	50	2.47.50	5
0.33.00	274	0.55.50	229	1.18.00	184	1.40.50	139	2.03.00	94	2.25.50	49	2.48.00	4
0.33.50	273	0.56.00	228	1.18.50	183	1.41.00	138	2.03.50	93	2.26.00	48	2.48.50	3
0.34.00	272	0.56.50	227	1.19.00	182	1.41.50	137	2.04.00	92	2.26.50	47	2.49.00	2
0.34.50	271	0.57.00	226	1.19.50	181	1.42.00	136	2.04.50	91	2.27.00	46	2.49.50	1
<u>0.35.00</u>	270	0.57.50	225	<u>1.20.00</u>	180	1.42.50	135	<u>2.05.00</u>	90	2.27.50	45	<u>2.50.00</u>	0
0.35.50	269	0.58.00	224	1.20.50	179	1.43.00	134	2.05.50	89	2.28.00	44		
0.36.00	268	0.58.50	223	1.21.00	178	1.43.50	133	2.06.00	88	2.28.50	43		
0.36.50	267	0.59.00	222	1.21.50	177	1.44.00	132	2.06.50	87	2.29.00	42		
0.37.00	266	0.59.50	221	1.22.00	176	1.44.50	131	2.07.00	86	2.29.50	41		
0.37.50	265	<u>1.00.00</u>	220	1.22.50	175	<u>1.45.00</u>	130	2.07.50	85	<u>2.30.00</u>	40		
0.38.00	264	1.00.50	219	1.23.00	174	1.45.50	129	2.08.00	84	2.30.50	39		
0.38.50	263	1.01.00	218	1.23.50	173	1.46.00	128	2.08.50	83	2.31.00	38		
0.39.00	262	1.01.50	217	1.24.00	172	1.46.50	127	2.09.00	82	2.31.50	37		
0.39.50	261	1.02.00	216	1.24.50	171	1.47.00	126	2.09.50	81	2.32.00	36		
<u>0.40.00</u>	260	1.02.50	215	<u>1.25.00</u>	170	1.47.50	125	<u>2.10.00</u>	80	2.32.50	35		
0.40.50	259	1.03.00	214	1.25.50	169	1.48.00	124	2.10.50	79	2.33.00	34		
0.41.00	258	1.03.50	213	1.26.00	168	1.48.50	123	2.11.00	78	2.33.50	33		
0.41.50	257	1.04.00	212	1.26.50	167	1.49.00	122	2.11.50	77	2.34.00	32		
0.42.00	256	1.04.50	211	1.27.00	166	1.49.50	121	2.12.00	76	2.34.50	31		
0.42.50	255	<u>1.05.00</u>	210	1.27.50	165	<u>1.50.00</u>	120	2.12.50	75	<u>2.35.00</u>	30		
0.43.00	254	1.05.50	209	1.28.00	164	1.50.50	119	2.13.00	74	2.35.50	29		
0.43.50	253	1.06.00	208	1.28.50	163	1.51.00	118	2.13.50	73	2.36.00	28		
0.44.00	252	1.06.50	207	1.29.00	162	1.51.50	117	2.14.00	72	2.36.50	27		
0.44.50	251	1.07.00	206	1.29.50	161	1.52.00	116	2.14.50	71	2.37.00	26		

05

EVENT RULES



LASER RUN

RUNNING/SHOOTING

PART A

THE EVENT

5.1 PRESENTATION OF THE EVENT

1 Description

2 Target Models

5.2 AUTHORITIES

1 Laser Run Director
2 Shooting Director
3 Range Officer
4 Target Officer
5 Shooting Judge
6 Running Director
7 Course Judges
8 Marshall

9 Starter
10 Deputy Starter
11 Starter's Assistants
12 Arrival Judges
13 Timekeepers
14 Announcer
15 Penalty Stop Area Judges
16 Equipment Controllers

5.3 ORGANISATION AND SCHEDULE

1 General Aspects
2 Starting Order

3 The Series
4 Range open

5.4 CONDUCT OF THE COMPETITION

1 Particular Safety Regulations
2 The Start
3 False Start
4 Shooting Series

5 Running Course
6 The Finish
7 Timing

5.5 SCORING

5.6 INFRINGEMENTS AND PENALTIES

- 1 10 seconds
- 2 Elimination
- 3 Disqualification

PART B

ANNEXES

Appendix 5A	PENALTY TABLE (see Article 5.6)
Appendix 5B1	POINTS TABLE – Individual and Relay: Seniors, Juniors, Under 19 (YA), Relay: Under 17 (YB)
Appendix 5B2	POINTS TABLE – Individual: Under 17 (YB)
Appendix 5B3	POINTS TABLE – Individual, Relay: Under 15 (YC), Relay: Under 13 (YD)
Appendix 5B4	POINTS TABLE – Individual: Under 13 (YD), Relay: Under 11 (YE), Under 9 (YF)
Appendix 5B5	POINTS TABLE – Individual: Under 11 (YE), Under 9 (YF)



5

RULES FOR LASER RUN RUNNING AND SHOOTING

PART A

THE EVENT

5.1 PRESENTATION OF THE EVENT

The Laser Run consists of shooting and running. The shooting involves laser pistol shooting in series at 10 metres in a range equipped with laser targets (as in Article 5.1.2 below) each of the four series of shooting being followed by Running for the distances shown immediately below.

5.1.1 The sequence

For all distances in the Senior, Junior and U19 age categories, the first lap (individual or relay) has no shooting.

	INDIVIDUAL		RELAY			INDIVIDUAL		RELAY	
	DIST	D TOT	DIST*	D TOT		DIST*	D TOT	DIST*	D TOT
Sen	5x600	3000	2x3x600	3600m	Under 15	3x600	1800	2x2x600	2400m
Jun	5x600	3000	2x3x600	3600m	Under 13	3x300	900	2x2x300	1200m
Under 19	5x600	3000	2x3x600	3600m	Under 11	2x300	600	2x2x300	1200m
Under 17	4x600	2400	2x2x600	2400m	Under 9	2x300	600	2x2x300	1200m

*Recommended distances

In YOG Qualification competitions, only the distance for Under 19 will be used.

5.1.2 Target Models

3 main types of laser target models are used for Modern Pentathlon competitions

- HT - Hit Laser Target
- HTM – Hit/ Miss Laser Target
- LPT - Laser Precision Target

5.2 AUTHORITIES

5.2.1 The LOC must appoint a Laser Run Director, who is overall in charge of the Laser Run.

The Laser Run Director:

- must appoint two deputy Laser Run directors, one for running and one for shooting;
- is responsible for the overall correct conduct of the Laser Run;
- permits the pentathletes to start warming-up.

5.2.2 Deputy Laser Run Director for Shooting (Shooting Director) who is in charge of:

- appointing and supervising: the Range Officers, Shooting Judges, Target Officers, Equipment Control Officers and the Range Personnel;
- the correct conduct of the shooting event;
- the rapid correction, in conjunction with the appointed Range Officers, of any equipment failure and for ensuring that the necessary experts and material are available to operate the range;
- informing the pentathletes and coaches of the final minute and 30 seconds remaining of warming-up time on the shooting range, which ends 3 minutes before start of competition;
- communicating all reported irregularities and penalties to the TDs/NTOs.

**5.2.3
Range Officers,
appointed one per 9
to 12 firing points, are
responsible for:**

- i) checking that pentathletes use the right firing points;
- ii) checking the names and start numbers of pentathletes to ensure that they conform to the Laser Run schedule, start list, scorecards and range register;
- iii) controlling pentathletes' clothing (shirts with name, numbers, armband, head phone, etc.);
- iv) assist in conducting possible weapon checks and post competition controls.
- v) checking that pentathletes assume the correct shooting position;
- vi) checking that the pentathletes do not disturb the other pentathletes;
- vii) applying and checking (in collaboration with the Shooting Judge) any 10 second penalty imposed on a pentathlete at their shooting station; before applying any penalty the range officers need to have approval from TD in range.
- viii) supervising the correct operation of the targets;
- ix) maintaining order on the range, with particular attention to safety;
- x) ensuring the recording of all irregularities, disturbances, penalties;
- xi) communicating all irregularities and penalties to the Shooting Director.

**5.2.4
Target Officers must:**

- i) prepare the shooting targets before the competition;
- ii) assist the Shooting Director during the entire competition;
- iii) assist with pistol testing and help the Equipment Controllers.

**5.2.5
The Shooting Director
must appoint one
Shooting Judge
for each shooting
station in Category A
competitions, and 1
Shooting Judge per
2 shooting stations
in all the other
competitions. The
Shooting Judges are
responsible for:**

- i) observing all shots fired;
- ii) ensuring that each pentathlete using a laser pistol touches, with the pistol, the shooting table between each shot;
- iii) after each shooting series, checking that the pistols are safe. A laser pistol is safe when untouched and placed on the shooting table pointing down the range;
- iv) informing the Shooting Director immediately as to any infringement of the rules;
- v) applying and in collaboration with the Range Officer checking any 10-second penalty imposed on a pentathlete at the shooting station.
- vi) With all pistol models, starting the stop-watch at the first attempted shot. The Shooting Judge must inform the pentathlete if the target lights do not indicate the first shot. The Shooting Judge must inform the pentathlete 5 seconds before the 50 second time limit expires by saying "Position XX 5 sec onds remain", and giving the command "Position XX GO", to the pentathlete when the 50 second time limit has expired.

**5.2.6
The Deputy Laser Run
Director for Running
(the Running Director)
is responsible for:**

- i) appointing and coordinating the activities of all Running Officials: Course Judges, Marshall, Starter, Deputy Starters, Starter's Assistants, Arrival Judges, Timekeepers, Recorders, Announcers, Last Penalty Stop Area Judges;
- ii) supervising the building of the course and the conduct of the event;
- iii) ensuring that the course or track and all equipment, including marketing banners, are in accordance with UIPM Rules;
- iv) ensuring that UIPM Rules are observed. The Running Director has authority to penalise pentathletes or other persons infringing these Rules;
- v) appointing special judges to coordinate the application of penalties from the starting area, shooting range penalties and the last penalties stop area.

5.2.7

The Course Judges are assistants of the Running Director. They do not have authority to make final decisions. They are placed by the Running Director so that they may best observe the running closely. In case of a foul, deviation from the course, unauthorised assistance or any violation of these rules by anyone they shall immediately report this to the Running Director orally and later in writing.

5.2.8

The Marshall has full charge of the start/finish area and the shooting range area. The Marshall must not allow any person other than the officials and competing pentathletes to enter or to remain there. The Marshall can be assisted by one or more assistants.



- 5.2.9** The Starter has entire control of the pentathletes while on their marks and is the sole judge of any fact connected with the start of the race. The Starter is responsible for synchronising their own, the Timekeepers' and Deputy Starters' watches and for giving the start signal to the first pentathlete when they are due to start and informing them before the start as to the time remaining before the start. The Starter will apply false start penalties and inform the Running Director who in turn will inform the Announcer.
- 5.2.10** The Deputy Starters, one for each start line, are under the supervision of the Starter. Deputy Starters must not have physical contact with the pentathletes. Their duties are to ensure that each pentathlete starts on time.
- 5.2.11** The Starter's Assistants, one for each start line, must check the pentathletes in the start-lanes and ensure that the pentathletes are lined up in correct order, at the right time, wearing the correct clothing, with the correct name and national code, and with numbers properly fastened front and back. Any violation of these rules must be reported immediately to the Running Director.
- 5.2.12** The Arrival Judges are responsible for registering the arrival order of the pentathletes at the finish line. Two groups of two judges working independently are needed.
- 5.2.13** The Timekeepers must use their stopwatches or manually operated electronic timers with or without digital readouts. All such timing devices are termed "watches" for the purpose of these Rules. Whether automatic timing is used or not, there should always be three Timekeepers, one of whom shall be the Chief Time Keeper. Their responsibility is to record the times of the pentathletes.
- 5.2.14** The Announcer is responsible for informing the public of the names and numbers of the pentathletes taking part in the Laser Run and other relevant information such as intermediate times. The Announcer must broadcast the first part of the count down to the start of the event up until one minute to departure, after which the countdown is under the control of the Starter. The results (placing, times and points) must be announced at the earliest possible moment after receipt of the information.
- 5.2.15** In the last Penalty Stop Area two Judges stay at the special penalty area located between 300-400m after the end of the shooting range, ready to apply penalties that cannot be applied at the shooting station.
- 5.2.16** Equipment Controllers must inspect, measure and verify the laser shooting equipment under the guidance of a UIPM laser expert, and test the weapons and other shooting equipment and clothing.

5.3 ORGANISATION AND SCHEDULE

5.3.1 General Aspects

Competition materials/equipment and clothing includes all the materials, equipment, competition gear and clothing which the pentathlete uses during the Laser Run. These materials, including any advertising, must be controlled before the competition.

- i) Equipment inspections may be organised before the competition. Pistols may be tested and controlled the day before the competition in which case the pistols will be kept by the LOC or sealed until warm-up. Random pistol tests may take place directly following the Laser Run. For UIPM category "A" competitions they are mandatory.
- ii) UIPM will provide the relevant laser test equipment, LOC will provide other shooting test equipment. Such pistol tests may be organised one day before the start of competition, separately for each gender, and/or post competition. All technical parameters, according to current Modern Pentathlon Equipment Regulations can be tested. Post-competition tests will take place immediately after the Laser Run. The shooting range shall be closed immediately after the last athlete has begun her/ his closing lap. The athletes selected for inspection and/ or 1 (one) representative may follow the testers and be present during the inspection and test of the pistol.

- iii) Pentathletes shall report at the materials/equipment and clothing inspection area at the scheduled time in order to have their equipment checked and marked, and their clothing inspected.
- iv) A Maximum of 1 reserve pistol or cylinder per pentathlete is to be brought to the Equipment Control Area and clothing checkpoint for inspection and marking. The reserve pistol must be taken directly to the range and deposited closed in the pentathletes' box at their own shooting station. The range staff will not permit the deposit of the reserve pistol after the warming-up time has ended.
- v) The Equipment Control Area must provide a complete set of gauges and instruments for equipment control before the event.
- vi) In case a pistol ceases to function the pentathlete can use another pistol provided this reserve pistol, provided by the pentathlete, has previously been inspected, approved and marked by the Equipment Control Area.
- vii) Pistols are checked as to calibre, weight, single shot and dimensions. All accepted pistols are marked as being allowed for competition. Laser pistols are checked also in the parameters according article A.5.8.2 in Modern Pentathlon 2017 Equipment Regulations.
- viii) All approved equipment must be marked with a seal or sticker and recorded on the control card. The Equipment Control Area must register the name of the pentathlete, the make (manufacturer), type and serial number of the pistol. Such approval is valid only for the relevant event. In the case of laser containers, the seal/sticker should be placed so that the laser container cannot be interfered with after the equipment test.
- ix) After the equipment has been approved, the pistol must not be modified or adjusted at any time before or during the event in any way that would conflict with the Laser Run Rules, unless with the agreement and under the supervision of the Range Officer.
- x) Any unapproved alterations or exchange will incur a penalty. If there are any doubts regarding any alteration, the pistol must be returned to the Equipment Control Area for re-inspection and approval.
- xi) Appropriate CO2 and air (tank or compressor) must be available on the weapon control area for the pentathletes using containers with air (as long as such containers are in use).
- xii) During a Relay competition only, a competing pentathlete's pistol may be laid on the shooting range table top. Only the pentathletes are authorised to move their pistols from the pistol storage under the table to the shooting table top.

5.3.2 Starting Order

Each pentathlete's score in points after the previous Pentathlon disciplines is totalled. These scores are converted to create staggered starting times for the Laser Run A difference of 1 pentathlon point equates to 1 second running. The pentathlete with most points will be the first to start at the Start Signal (0'00") and will shoot at station No 1.

5.3.3 The Series

The Shooting competition is in series. Each series consists of hitting 5 targets with an unlimited number of shots in a maximum time of 50 seconds on a target with a valid zone of dimension 59.5mm. If after 50 seconds one or more targets have not been hit (or the pentathlete has not hit the valid zone 5 times) the pentathlete may start running without being penalised, provided the pistol is made safe in accordance with Rule 5.4.1.

5.3.4 Range open

- i) A minimum of 20 minutes must be given for warm-up. In the Semi-finals and Finals of any competition organised with 3 (three) or more disciplines in the New Format a general warm-up time of 60 minutes will be given before the whole competitions starts. The shooting range must be open during that time period for the warm-up. The LOC will confirm the format of the warm up at the Technical Meeting.
- ii) The Laser Run Director asks pentathletes to enter their shooting stations. Each shooting station corresponds to the pentathlete's starting position. Pentathlete No1 shoots at station No1, pentathlete No 2 shoots at station No 2 and so on.
- iii) There will be a preparation time of 12 minutes in the Semi-finals and Finals of the New Format competitions before the start of the laser run event. The preparation time commences from the end of the previous discipline until 3 minutes prior to the start of the laser run event.



- iv) Warm-up in the Qualification for the Semi-finals will start, after the appropriate command "RANGE OPEN" by the Shooting Director.
- v) One coach per athlete is allowed to assist, but is requested to stay in the area behind the judges during the entire warm-up in order to avoid disturbance and clashes with running athletes. A "one way" system is in place to avoid disturbance and clashes with running athletes. 10 minutes in Qualifications and 5 minutes in Semi-finals and Finals before the start all coaches have to clear the field of play on the command "COACHES PLEASE LEAVE THE RANGE".
- vi) During the warm up period or preparation time pentathletes may run and shoot an unlimited number of shots. The use of constant beam (for laser pistols) is only authorised in the warm-up.
- vii) At the Shooting Station, pentathletes may use water and towels, which must be kept under the table with the reserve pistol and any binoculars used during warm up. No video camera is allowed in the shooting station. During the actual competition, the shooting table must be cleared of any other items than the pistol of the athlete and the provided protective foam.
- viii) The Shooting Director will inform the pentathletes of the last 5 minutes, the last minute and 30 seconds remaining of the shooting session warm-up or preparation time.
- ix) After the warm-up or preparation and before the start signal pistols must be on the assigned shooting station. The reserve pistol must be in its box, under the shooting table.
- x) During the warm-up or preparation coaches may assist and communicate with pentathletes from a specially marked area for coaches outside the shooting stations and the running corridor.
- xi) The Shooting warm-up or preparation session must be ended 3 minutes before the start of the Laser Run competition and the pentathletes must go to the Laser Run starting line.

5.4 CONDUCT OF THE COMPETITION

5.4.1 Particular Safety Regulations

- i) Safety Regulations are to be established by the LOC in accordance with the respective national laws of the organising country. The LOC is responsible for informing all event participants of these rules and providing for their application.
- ii) The safety of all event participants and spectators requires self-discipline, careful attention to pistol handling and caution in moving about the competition area by everybody concerned. It is the responsibility of pentathletes and team representatives to ensure they handle their pistols safely and efficiently.
- iii) The UIPM TD/NTO, Shooting Director or Range Officers may stop the Laser Run at any time in the interest of safety. Pentathletes and team officials must immediately notify Range Officers of any situation that may be dangerous or which may cause an accident.
When the pistol is not on the firing point, it must always be in its box.
- iv) Pistols may be loaded only at the firing station, and only after the command "Range Open" is given.
- v) If the command "STOP" is given, all pentathletes must stop shooting immediately and place the pistol on the table pointing in a safe direction, not cocked and untouched.
- vi) After the last shot of each shooting series the pentathlete must ascertain before leaving the firing point, that the pistol is in safe mode Laser pistols are automatically in "safe mode" (the shot cannot be triggered) if the pentathlete does not "reload" (reset the trigger)

5.4.2 The Start

- i) The handicap start must use three gates: two gates A and B and one additional Penalty ("P") Gate. The Start Line for running shall be denoted by a white line 5cm wide on the ground.
- ii) Pentathletes with a handicap after the previous events of more than 1 minute and 30 seconds will start in a pack start at 1'30".
- iii) The Laser Run has a staggered start at the beginning of the competition with completion of the first lap of running distance for the Senior, Junior and U19 athletes, then the first shooting series of 5 hits take place.
- iv) In the event of a false start from the shooting line the same rules for a false start will be applied: a 10 second penalty for a false start and disqualification in the case of a blatant attempt to start too early .

- v) Pentathletes are responsible for knowing their own start time, for being at the start line on time and for starting on time.
- vi) The Announcer will announce "10 minutes" and "5 minutes" prior to the start of the Laser Run. The Announcer, under the command of the Laser Run Director, will declare warming-up or preparation time on the shooting range finished. All pentathletes must be at the start area and the Starter/Starter Assistants will begin lining up the pentathletes. One minute before the start, all pentathletes must be at the corresponding gates assembled in the order of their start time.
- vii) The Starter will announce – "**One minute to start**"; "30 seconds", "20 seconds" and "10 seconds to the Start." After the OK has been given by the Timekeepers and the Laser Run Director, the Starter will tell the first pentathlete "**Take your Marks**", followed by the start signal. All timing equipment will start at the start signal. At the start area, a start clock must be placed so that it is easily readable from the start line and by the timekeepers. The start time for the first pentathlete will be '00.00'. Pentathlete No 1 starts at time '00.00'. Pentathlete No 2 starts at 'x' seconds depending on the points difference at that stage, and so on.
- viii) The Senior, Junior and U19 pentathletes must run the first lap of the running distance and pass throughout the shooting range without shooting. After completing the first lap, athletes go to the shooting range and start the first shooting series of 5 hits.

5.4.3 False Start

- i) The Starter/Announcer must immediately announce to the pentathlete and spectators if a pentathlete that has started too early and inform them of their false start.
- ii) A pentathlete starting late will not be penalised, but their time will be taken from the moment they should have started according to the start list.
- iii) A false start occurs if a pentathlete crosses or touches the start line before the official start time. Before the start both feet must be behind the start line.

5.4.4 Shooting Series

- i) Each pentathlete must always use their allocated shooting station. Each team must use always the same designated target(s).
- ii) Pentathletes are responsible for shooting on the correct target.
- iii) The pentathlete must stand with both feet on the ground, freely and without touching the table with any part of their body, completely within the shooting station. Otherwise, 10 points penalty are applied for each infringement. The entire pistol must be held and fired with one hand only. The unarmed hand must not give support to the armed arm or hand. Otherwise, the pentathlete will be eliminated.
- iv) The pistol must touch the table between each shot otherwise the pentathlete will be penalised.
- v) Only after successfully completing each shooting series, or 50 seconds has elapsed, may the pentathlete start running. After the last series the pentathlete must cross the running finish line.
- vi) Malfunctions are not taken into consideration. Should a pistol cease to function, the pentathlete may use the reserve pistol or another cylinder that must have also been approved by the Equipment Control Section. If a shot has not fired due a malfunction, the pentathlete may use the reserve pistol without interruption. If the reserve pistol also does not work the pentathlete must wait at the shooting station until the 50 second shooting time has expired before starting running.
- vii) Reserve targets can be used, but the athlete needs permission from the range officer/ TD to change to a reserve target.

5.4.5 Running Course

- i) Pentathletes must follow the course from crossing the start line, and after completing the first lap of the running distance without shooting (only for Senior, Junior and U19 events) going to the shooting range for each shooting series and, having completed the shooting, cross the finish line.
- ii) If informed by a Judge and announced by the sound system, the pentathlete must stop and remain in the Last Penalty Stop Area for the time indicated.
- iii) During the race no pentathlete may accept any physical assistance or refreshment. In exceptional circumstances this can be allowed if so decided by the Pentathlon Director, Laser Run Director and Technical Delegate. Running by a non-competitor with or behind a pentathlete may be unauthorised assistance. A hands-on medical examination by official medical personnel during the progress of the event and verbal or other communication from a person not on the course is not unauthorised assistance.
- iv) A pentathlete/team must complete the course.

**5.4.6****The Finish**

The last 30 metres shall be straight and well visible for TV cameras and spectators. The finish line shall be denoted by a white line on the ground 5cm wide. Pentathletes will be timed and placed in the order in which any part of their torso (as distinguished from the head, neck, arms, legs, hands or feet) reaches the vertical plane of the nearer edge of the finish line.

5.4.7**Timing**

Times for all finishers shall be recorded. Three alternative methods of timekeeping are recognised as official: Manual Timing; Fully Automatic Timing obtained from a Photo Finish System; Timing provided by a Transponder System. In Category "A" competitions manual timing is not allowed.

When automatic judging and timing equipment is provided, it must be used to determine the winner, placings and times for each athlete. The results and time so determined has precedence over the decisions of Timekeepers. In the case of a breakdown or mechanical failure, the timekeepers' decisions will take precedence and reference must be made to all manual times recorded. In all Category "A" Competitions video recording is compulsory at the finish line.

- i) Manual Timing:
 - a) Timekeepers shall be in line with the finish and where possible.
 - b) Timekeepers shall use manually operated electronic timers with digital readouts.
 - c) Three official Timekeepers (one of whom shall be the Chief Timekeeper) shall time all the athletes.
 - d) Each Timekeeper shall act independently and without showing his watch to, or discussing his time with, any other person, shall enter his time on the official form and, after signing it, hand it to the Chief Timekeeper who may examine the watches to verify the reported times.
 - e) For all manually-timed races, times shall be read and recorded as an exact 1/10th of a second.
 - f) If, after converting as indicated above, two of the three watches agree and the third disagrees, the time recorded by the two shall be the official time. If all three watches disagree, the middle time shall be official. If only two times are available and they disagree, the greater time shall be official.
 - g) The Chief Timekeeper, acting in accordance with the Rules mentioned above, shall decide the official time for each athlete and provide the result for distribution.
- ii) Fully Automatic Timing obtained from a Photo Finish System:
 - a) Fully Automatic Timing and Photo Finish System approved by UIPM should be used at all Olympic Competitions. It shall be started automatically by the Starter.
 - b) The System must record the finish through a camera with a vertical slit, positioned in the extension of the finish line, producing a continuous image. The image must also be synchronised with a uniformly marked time-scale graduated in 1/100th of a second.
 - c) The placing of the athletes shall be identified from the image by means of a cursor with its reading line perpendicular to the time scale.
 - d) The System must automatically determine and record the finish times of the pentathlete and must be able to produce a printed image which shows the time of every pentathlete.
 - e) There should be at least two photo finish cameras in action, one from each side. Preferably, these timing systems should be technically independent, i.e. with different power supplies and recording.
 - f) The Running Director shall determine the placing of the pentathletes and their official times. He shall ensure that these results are correctly entered in or transferred to the competition results system and conveyed to the Results team.
 - g) Times from Photo Finish System shall be regarded as official unless for

any reason the appropriate official decides that they obviously must be inaccurate. If such is the case, the times of the back-up Timekeepers, if possible adjusted based on information on time intervals obtained from the Photo Finish image, shall be official. Such back-up Timekeepers must be appointed where any possibility exists of failure of the timing system. If a "fractional handicap" start order has been used, this must be taken into consideration when producing final placings and final result list.

- h) Times shall be read and recorded from the Photo Finish image as follows; the time shall be read to 1/100th of a second and recorded to 1/10th of a second.
- iii) Timing provided by a Transponder System:
 - a) None of the equipment used at the start, along the course or at the finish line should constitute a significant obstacle or barrier to the progress of a pentathlete.
 - b) The weight of the transponder and its housing carried on the pentathletes' uniform, bib or shoe is not significant.
 - c) The System is started by the Starter's gun or synchronised with the start signal.
 - d) The System requires no action by an athlete during the competition, at the finish or at any stage in the result processing.
 - e) The resolution is 1/10th of a second (i.e. it can separate athletes finishing 1/10th of a second apart). For all races, time shall be read to 1/10th of a second and recorded to the whole second.
 - f) When transponders are used on the feet Article 5.4.7 still applies.

500 Modern Pentathlon points are awarded for obtaining the following times ± 1 point for each second faster or slower.

5.5 Scoring

	Individual		Relay	
	Distance	500 pts	Distance	500 pts
Senior, Junior, Under 19	3000m	13'20"	3600m	13'20"
Under 17	2400m	10'30"	2400m	13'20"
Under 15	1800m	7'40"	2400m	7'40"
Under 13	900m	5'20"	1200m	5'20"
Under 11	600m	4'00"	1200m	5'20"
Under 9	600m	4'00"	1200m	5'20"



5.6 INFRINGEMENTS AND PENALTIES

5.6.1

A pentathlete or team is penalised by a time penalty of Ten Seconds for each of the following offences:

A pentathlete or team is penalised by a time penalty of **Ten Seconds** for each of the following offences:

- i) contravening clothing regulations;
- ii) modifying the dimensions of the start numbers;
- iii) a false start;
- iv) not placing the pistol safely on the table after warming-up has ended and after each shooting series*;
- v) not touching the shooting table between each shot*; before applying such penalty a warning must be issued. The respective judge and range officer need to have approval from TD in range before applying such penalty. This penalty will be applied for each infringement after first warning.
- vi) if a coach during the warming-up is outside the designated coaches area and assists a pentathlete: for the first time, a warning. Any subsequent offence, a 10 second penalty for the pentathlete;
- vii) For the second time removing their pistol(s) from the box/case before the official warming-up period has started. The first breach will result in a warning; not standing freely, without touching the table, with both feet on the ground within the shooting station; before applying such penalty, a warning must be issued.
- viii)

5.6.2

A pentathlete or team is eliminated for:

A pentathlete or team is **eliminated** for:

- i) not completing the course;
- ii) deviation, deliberate or not, from the course which in the opinion of the Course Judge gained a material advantage;
- iv) unauthorised assistance, if not disqualified;
- v) using an unapproved pistol;
- vi) shooting on the wrong target;
- vii) not stopping at the last stop penalty area when instructed by an official;
- viii) using constant beam during the competition series and/or audio communication outside preparation and warm-up time.
- ix) holding pistol with two hands or giving support to the armed arm.
- x) incorrect change over in the relay
- xi) starting the running leg before the shooting time has expired without having completed successfully each shooting series*;
4 green lights → **Elimination**

* These penalties are paid at the shooting range, with the exception of the final shooting series where they are paid in the Last Penalty Stop Area.

5.6.3

A pentathlete or team is disqualified for:

A pentathlete or team is **disqualified** for:

- i) modifying or adjusting an officially approved pistol so that it violates the rules;
- ii) exchanging their pistol in violation of the rules;
- iii) a blatant attempt to start too early;
- iv) jostling, running across or obstructing another pentathlete so as to impede their progress.
- v) starting the running leg before the shooting time has expired without having completed successfully each shooting series*;
3 (or less) green lights → **Disqualification** (considered as blatant attempt to start early)

* These penalties are paid at the shooting range, with the exception of the final shooting series where they are paid in the Last Penalty Stop Area.

**PENALTY TABLE
LASER RUN**

Appendix 5A

OFFENCES	Rule	Penalty		
		1st time	Subsequent	Paid at *
Contravening clothing regulations	5.6.1 i	10"		PG
Modifying dimensions of start numbers	5.6.1 ii	10"		PG
False start	5.6.1 iii	10"		SL
Not placing a pistol safely on the table after warm-up or shooting series	5.6.1 iv	10"	10"	SL or LPA
Not touching the shooting table between each shot	5.6.1 v	Warning	10"	SL or LPA
Coach assistance during warm-up outside the designated coaches area	5.6.1.vi	Warning	10"	PG
Not having the pistol in the box before the official warm-up period has started	5.6.1 vii	Warning	10"	PG
not standing freely, without touching the table, with both feet on the ground	5.6.1 viii	Warning	10"	SL or LPA
Not completing the course	5.6.2 i		Elimination	
Deviation, deliberate or not, from the course	5.6.2 ii		Elimination	
Unauthorised assistance	5.6.2 iii		Elimination	
Using a non-approved pistol	5.6.2 iv		Elimination	
Shooting on a wrong target	5.6.2 v		Elimination	
Not stopping at the last penalty area when instructed by an official	5.6.2 vi		Elimination	
Using constant beam during the competition series and or audio communication outside of preparation and warm-up time.	5.6.2 vii		Elimination	
holding pistol with two hands or giving support to the armed arm.	5.6.2 viii		Elimination	
incorrect change of in the relay	5.6.2 ix		Elimination	
Start running with before having successfully completed the shooting series ("5 green lights") with only 4 green lights.	5.6.2 x		Elimination	
Modifying or adjusting the approved pistol	5.6.3 i		Disqualification	
Exchanging for a non approved pistol	5.6.3 ii		Disqualification	
Blatant attempt to start too early	5.6.3 iii		Disqualification	
Jostling, running across, or obstructing another athlete	5.6.3 iv		Disqualification	
Start running with before having successfully completed the shooting series ("5 green lights") with only 3 (or less) green lights.	5.6.3 v		Disqualification	

* - Penalty Start Gate – PG; Shooting Line – SL; Last Penalty Area - LPA

The penalties for the offences of 5.6.1 iv and viii, if committed in the 3rd shooting series, will be paid in the Last penalty Area.



**POINTS TABLE
LASER RUN**

Appendix 5B1

**Individual: Seniors,
Juniors, U19**

**Relay: Seniors,
Juniors, U19 & 17**

TIME	PTS	TIME	PTS	TIME	PTS	TIME	PTS	TIME	PTS	TIME	PTS
<u>10:00</u>	700	<u>10:40</u>	660	<u>11:20</u>	620	<u>12:00</u>	580	<u>12:40</u>	540	<u>13:20</u>	500
10:01	699	10:41	659	11:21	619	12:01	579	12:41	539	13:21	499
10:02	698	10:42	658	11:22	618	12:02	578	12:42	538	13:22	498
10:03	697	10:43	657	11:23	617	12:03	577	12:43	537	13:23	497
10:04	696	10:44	656	11:24	616	12:04	576	12:44	536	13:24	496
10:05	695	10:45	655	11:25	615	12:05	575	12:45	535	13:25	495
10:06	694	10:46	654	11:26	614	12:06	574	12:46	534	13:26	494
10:07	693	10:47	653	11:27	613	12:07	573	12:47	533	13:27	493
10:08	692	10:48	652	11:28	612	12:08	572	12:48	532	13:28	492
10:09	691	10:49	651	11:29	611	12:09	571	12:49	531	13:29	491
<u>10:10</u>	690	<u>10:50</u>	650	<u>11:30</u>	610	<u>12:10</u>	570	<u>12:50</u>	530	<u>13:30</u>	490
10:11	689	10:51	649	11:31	609	12:11	569	12:51	529	13:31	489
10:12	688	10:52	648	11:32	608	12:12	568	12:52	528	13:32	488
10:13	687	10:53	647	11:33	607	12:13	567	12:53	527	13:33	487
10:14	686	10:54	646	11:34	606	12:14	566	12:54	526	13:34	486
10:15	685	10:55	645	11:35	605	12:15	565	12:55	525	13:35	485
10:16	684	10:56	644	11:36	604	12:16	564	12:56	524	13:36	484
10:17	683	10:57	643	11:37	603	12:17	563	12:57	523	13:37	483
10:18	682	10:58	642	11:38	602	12:18	562	12:58	522	13:38	482
10:19	681	10:59	641	11:39	601	12:19	561	12:59	521	13:39	481
<u>10:20</u>	680	<u>11:00</u>	640	<u>11:40</u>	600	<u>12:20</u>	560	<u>13:00</u>	520	<u>13:40</u>	480
10:21	679	11:01	639	11:41	599	12:21	559	13:01	519	13:41	479
10:22	678	11:02	638	11:42	598	12:22	558	13:02	518	13:42	478
10:23	677	11:03	637	11:43	597	12:23	557	13:03	517	13:43	477
10:24	676	11:04	636	11:44	596	12:24	556	13:04	516	13:44	476
10:25	675	11:05	635	11:45	595	12:25	555	13:05	515	13:45	475
10:26	674	11:06	634	11:46	594	12:26	554	13:06	514	13:46	474
10:27	673	11:07	633	11:47	593	12:27	553	13:07	513	13:47	473
10:28	672	11:08	632	11:48	592	12:28	552	13:08	512	13:48	472
10:29	671	11:09	631	11:49	591	12:29	551	13:09	511	13:49	471
<u>10:30</u>	670	<u>11:10</u>	630	<u>11:50</u>	590	<u>12:30</u>	550	<u>13:10</u>	510	<u>13:50</u>	470
10:31	669	11:11	629	11:51	589	12:31	549	13:11	509	13:51	469
10:32	668	11:12	628	11:52	588	12:32	548	13:12	508	13:52	468
10:33	667	11:13	627	11:53	587	12:33	547	13:13	507	13:53	467
10:34	666	11:14	626	11:54	586	12:34	546	13:14	506	13:54	466
10:35	665	11:15	625	11:55	585	12:35	545	13:15	505	13:55	465
10:36	664	11:16	624	11:56	584	12:36	544	13:16	504	13:56	464
10:37	663	11:17	623	11:57	583	12:37	543	13:17	503	13:57	463
10:38	662	11:18	622	11:58	582	12:38	542	13:18	502	13:58	462
10:39	661	11:19	621	11:59	581	12:39	541	13:19	501	13:59	461

TIME	PTS	TIME	PTS	TIME	PTS	TIME	PTS	TIME	PTS	TIME	PTS
14:00	460	14:40	420	15:20	380	16:00	340	16:40	300	17:20	260
14:01	459	14:41	419	15:21	379	16:01	339	16:41	299	17:21	259
14:02	458	14:42	418	15:22	378	16:02	338	16:42	298	17:22	258
14:03	457	14:43	417	15:23	377	16:03	337	16:43	297	17:23	257
14:04	456	14:44	416	15:24	376	16:04	336	16:44	296	17:24	256
14:05	455	14:45	415	15:25	375	16:05	335	16:45	295	17:25	255
14:06	454	14:46	414	15:26	374	16:06	334	16:46	294	17:26	254
14:07	453	14:47	413	15:27	373	16:07	333	16:47	293	17:27	253
14:08	452	14:48	412	15:28	372	16:08	332	16:48	292	17:28	252
14:09	451	14:49	411	15:29	371	16:09	331	16:49	291	17:29	251
14:10	450	14:50	410	15:30	370	16:10	330	16:50	290	17:30	250
14:11	449	14:51	409	15:31	369	16:11	329	16:51	289	17:31	249
14:12	448	14:52	408	15:32	368	16:12	328	16:52	288	17:32	248
14:13	447	14:53	407	15:33	367	16:13	327	16:53	287	17:33	247
14:14	446	14:54	406	15:34	366	16:14	326	16:54	286	17:34	246
14:15	445	14:55	405	15:35	365	16:15	325	16:55	285	17:35	245
14:16	444	14:56	404	15:36	364	16:16	324	16:56	284	17:36	244
14:17	443	14:57	403	15:37	363	16:17	323	16:57	283	17:37	243
14:18	442	14:58	402	15:38	362	16:18	322	16:58	282	17:38	242
14:19	441	14:59	401	15:39	361	16:19	321	16:59	281	17:39	241
14:20	440	15:00	400	15:40	360	16:20	320	17:00	280	17:40	240
14:21	439	15:01	399	15:41	359	16:21	319	17:01	279	17:41	239
14:22	438	15:02	398	15:42	358	16:22	318	17:02	278	17:42	238
14:23	437	15:03	397	15:43	357	16:23	317	17:03	277	17:43	237
14:24	436	15:04	396	15:44	356	16:24	316	17:04	276	17:44	236
14:25	435	15:05	395	15:45	355	16:25	315	17:05	275	17:45	235
14:26	434	15:06	394	15:46	354	16:26	314	17:06	274	17:46	234
14:27	433	15:07	393	15:47	353	16:27	313	17:07	273	17:47	233
14:28	432	15:08	392	15:48	352	16:28	312	17:08	272	17:48	232
14:29	431	15:09	391	15:49	351	16:29	311	17:09	271	17:49	231
14:30	430	15:10	390	15:50	350	16:30	310	17:10	270	17:50	230
14:31	429	15:11	389	15:51	349	16:31	309	17:11	269	17:51	229
14:32	428	15:12	388	15:52	348	16:32	308	17:12	268	17:52	228
14:33	427	15:13	387	15:53	347	16:33	307	17:13	267	17:53	227
14:34	426	15:14	386	15:54	346	16:34	306	17:14	266	17:54	226
14:35	425	15:15	385	15:55	345	16:35	305	17:15	265	17:55	225
14:36	424	15:16	384	15:56	344	16:36	304	17:16	264	17:56	224
14:37	423	15:17	383	15:57	343	16:37	303	17:17	263	17:57	223
14:38	422	15:18	382	15:58	342	16:38	302	17:18	262	17:58	222
14:39	421	15:19	381	15:59	341	16:39	301	17:19	261	17:59	221



TIME	PTS	TIME	PTS	TIME	PTS	TIME	PTS	TIME	PTS	TIME	PTS
18:00	220	18:40	180	19:20	140	20:00	100	20:40	60	21:20	20
18:01	219	18:41	179	19:21	139	20:01	99	20:41	59	21:21	19
18:02	218	18:42	178	19:22	138	20:02	98	20:42	58	21:22	18
18:03	217	18:43	177	19:23	137	20:03	97	20:43	57	21:23	17
18:04	216	18:44	176	19:24	136	20:04	96	20:44	56	21:24	16
18:05	215	18:45	175	19:25	135	20:05	95	20:45	55	21:25	15
18:06	214	18:46	174	19:26	134	20:06	94	20:46	54	21:26	14
18:07	213	18:47	173	19:27	133	20:07	93	20:47	53	21:27	13
18:08	212	18:48	172	19:28	132	20:08	92	20:48	52	21:28	12
18:09	211	18:49	171	19:29	131	20:09	91	20:49	51	21:29	11
18:10	210	18:50	170	19:30	130	20:10	90	20:50	50	21:30	10
18:11	209	18:51	169	19:31	129	20:11	89	20:51	49	21:31	9
18:12	208	18:52	168	19:32	128	20:12	88	20:52	48	21:32	8
18:13	207	18:53	167	19:33	127	20:13	87	20:53	47	21:33	7
18:14	206	18:54	166	19:34	126	20:14	86	20:54	46	21:34	6
18:15	205	18:55	165	19:35	125	20:15	85	20:55	45	21:35	5
18:16	204	18:56	164	19:36	124	20:16	84	20:56	44	21:36	4
18:17	203	18:57	163	19:37	123	20:17	83	20:57	43	21:37	3
18:18	202	18:58	162	19:38	122	20:18	82	20:58	42	21:38	2
18:19	201	18:59	161	19:39	121	20:19	81	20:59	41	21:39	1
18:20	200	19:00	160	19:40	120	20:20	80	21:00	40	21:40	0
18:21	199	19:01	159	19:41	119	20:21	79	21:01	39		
18:22	198	19:02	158	19:42	118	20:22	78	21:02	38		
18:23	197	19:03	157	19:43	117	20:23	77	21:03	37		
18:24	196	19:04	156	19:44	116	20:24	76	21:04	36		
18:25	195	19:05	155	19:45	115	20:25	75	21:05	35		
18:26	194	19:06	154	19:46	114	20:26	74	21:06	34		
18:27	193	19:07	153	19:47	113	20:27	73	21:07	33		
18:28	192	19:08	152	19:48	112	20:28	72	21:08	32		
18:29	191	19:09	151	19:49	111	20:29	71	21:09	31		
18:30	190	19:10	150	19:50	110	20:30	70	21:10	30		
18:31	189	19:11	149	19:51	109	20:31	69	21:11	29		
18:32	188	19:12	148	19:52	108	20:32	68	21:12	28		
18:33	187	19:13	147	19:53	107	20:33	67	21:13	27		
18:34	186	19:14	146	19:54	106	20:34	66	21:14	26		
18:35	185	19:15	145	19:55	105	20:35	65	21:15	25		
18:36	184	19:16	144	19:56	104	20:36	64	21:16	24		
18:37	183	19:17	143	19:57	103	20:37	63	21:17	23		
18:38	182	19:18	142	19:58	102	20:38	62	21:18	22		
18:39	181	19:19	141	19:59	101	20:39	61	21:19	21		

**POINTS TABLE
LASER RUN**

Appendix 5B2

Individual: U17

TIME	PTS	TIME	PTS	TIME	PTS	TIME	PTS	TIME	PTS	TIME	PTS
<u>07:10</u>	700	<u>07:50</u>	660	<u>08:30</u>	620	<u>09:10</u>	580	<u>09:50</u>	540	<u>10:30</u>	500
07:11	699	07:51	659	08:31	619	09:11	579	09:51	539	10:31	499
07:12	698	07:52	658	08:32	618	09:12	578	09:52	538	10:32	498
07:13	697	07:53	657	08:33	617	09:13	577	09:53	537	10:33	497
07:14	696	07:54	656	08:34	616	09:14	576	09:54	536	10:34	496
07:15	695	07:55	655	08:35	615	09:15	575	09:55	535	10:35	495
07:16	694	07:56	654	08:36	614	09:16	574	09:56	534	10:36	494
07:17	693	07:57	653	08:37	613	09:17	573	09:57	533	10:37	493
07:18	692	07:58	652	08:38	612	09:18	572	09:58	532	10:38	492
07:19	691	07:59	651	08:39	611	09:19	571	09:59	531	10:39	491
<u>07:20</u>	690	<u>08:00</u>	650	<u>08:40</u>	610	<u>09:20</u>	570	<u>10:00</u>	530	<u>10:40</u>	490
07:21	689	08:01	649	08:41	609	09:21	569	10:01	529	10:41	489
07:22	688	08:02	648	08:42	608	09:22	568	10:02	528	10:42	488
07:23	687	08:03	647	08:43	607	09:23	567	10:03	527	10:43	487
07:24	686	08:04	646	08:44	606	09:24	566	10:04	526	10:44	486
07:25	685	08:05	645	08:45	605	09:25	565	10:05	525	10:45	485
07:26	684	08:06	644	08:46	604	09:26	564	10:06	524	10:46	484
07:27	683	08:07	643	08:47	603	09:27	563	10:07	523	10:47	483
07:28	682	08:08	642	08:48	602	09:28	562	10:08	522	10:48	482
07:29	681	08:09	641	08:49	601	09:29	561	10:09	521	10:49	481
<u>07:30</u>	680	<u>08:10</u>	640	<u>08:50</u>	600	<u>09:30</u>	560	<u>10:10</u>	520	<u>10:50</u>	480
07:31	679	08:11	639	08:51	599	09:31	559	10:11	519	10:51	479
07:32	678	08:12	638	08:52	598	09:32	558	10:12	518	10:52	478
07:33	677	08:13	637	08:53	597	09:33	557	10:13	517	10:53	477
07:34	676	08:14	636	08:54	596	09:34	556	10:14	516	10:54	476
07:35	675	08:15	635	08:55	595	09:35	555	10:15	515	10:55	475
07:36	674	08:16	634	08:56	594	09:36	554	10:16	514	10:56	474
07:37	673	08:17	633	08:57	593	09:37	553	10:17	513	10:57	473
07:38	672	08:18	632	08:58	592	09:38	552	10:18	512	10:58	472
07:39	671	08:19	631	08:59	591	09:39	551	10:19	511	10:59	471
<u>07:40</u>	670	<u>08:20</u>	630	<u>09:00</u>	590	<u>09:40</u>	550	<u>10:20</u>	510	<u>11:00</u>	470
07:41	669	08:21	629	09:01	589	09:41	549	10:21	509	11:01	469
07:42	668	08:22	628	09:02	588	09:42	548	10:22	508	11:02	468
07:43	667	08:23	627	09:03	587	09:43	547	10:23	507	11:03	467
07:44	666	08:24	626	09:04	586	09:44	546	10:24	506	11:04	466
07:45	665	08:25	625	09:05	585	09:45	545	10:25	505	11:05	465
07:46	664	08:26	624	09:06	584	09:46	544	10:26	504	11:06	464
07:47	663	08:27	623	09:07	583	09:47	543	10:27	503	11:07	463
07:48	662	08:28	622	09:08	582	09:48	542	10:28	502	11:08	462
07:49	661	08:29	621	09:09	581	09:49	541	10:29	501	11:09	461



TIME	PTS	TIME	PTS	TIME	PTS	TIME	PTS	TIME	PTS	TIME	PTS
<u>11:10</u>	460	<u>11:50</u>	420	<u>12:30</u>	380	<u>13:10</u>	340	<u>13:50</u>	300	<u>14:30</u>	260
11:11	459	11:51	419	12:31	379	13:11	339	13:51	299	14:31	259
11:12	458	11:52	418	12:32	378	13:12	338	13:52	298	14:32	258
11:13	457	11:53	417	12:33	377	13:13	337	13:53	297	14:33	257
11:14	456	11:54	416	12:34	376	13:14	336	13:54	296	14:34	256
11:15	455	11:55	415	12:35	375	13:15	335	13:55	295	14:35	255
11:16	454	11:56	414	12:36	374	13:16	334	13:56	294	14:36	254
11:17	453	11:57	413	12:37	373	13:17	333	13:57	293	14:37	253
11:18	452	11:58	412	12:38	372	13:18	332	13:58	292	14:38	252
11:19	451	11:59	411	12:39	371	13:19	331	13:59	291	14:39	251
<u>11:20</u>	450	<u>12:00</u>	410	<u>12:40</u>	370	<u>13:20</u>	330	<u>14:00</u>	290	<u>14:40</u>	250
11:21	449	12:01	409	12:41	369	13:21	329	14:01	289	14:41	249
11:22	448	12:02	408	12:42	368	13:22	328	14:02	288	14:42	248
11:23	447	12:03	407	12:43	367	13:23	327	14:03	287	14:43	247
11:24	446	12:04	406	12:44	366	13:24	326	14:04	286	14:44	246
11:25	445	12:05	405	12:45	365	13:25	325	14:05	285	14:45	245
11:26	444	12:06	404	12:46	364	13:26	324	14:06	284	14:46	244
11:27	443	12:07	403	12:47	363	13:27	323	14:07	283	14:47	243
11:28	442	12:08	402	12:48	362	13:28	322	14:08	282	14:48	242
11:29	441	12:09	401	12:49	361	13:29	321	14:09	281	14:49	241
<u>11:30</u>	440	<u>12:10</u>	400	<u>12:50</u>	360	<u>13:30</u>	320	<u>14:10</u>	280	<u>14:50</u>	240
11:31	439	12:11	399	12:51	359	13:31	319	14:11	279	14:51	239
11:32	438	12:12	398	12:52	358	13:32	318	14:12	278	14:52	238
11:33	437	12:13	397	12:53	357	13:33	317	14:13	277	14:53	237
11:34	436	12:14	396	12:54	356	13:34	316	14:14	276	14:54	236
11:35	435	12:15	395	12:55	355	13:35	315	14:15	275	14:55	235
11:36	434	12:16	394	12:56	354	13:36	314	14:16	274	14:56	234
11:37	433	12:17	393	12:57	353	13:37	313	14:17	273	14:57	233
11:38	432	12:18	392	12:58	352	13:38	312	14:18	272	14:58	232
11:39	431	12:19	391	12:59	351	13:39	311	14:19	271	14:59	231
<u>11:40</u>	430	<u>12:20</u>	390	<u>13:00</u>	350	<u>13:40</u>	310	<u>14:20</u>	270	<u>15:00</u>	230
11:41	429	12:21	389	13:01	349	13:41	309	14:21	269	15:01	229
11:42	428	12:22	388	13:02	348	13:42	308	14:22	268	15:02	228
11:43	427	12:23	387	13:03	347	13:43	307	14:23	267	15:03	227
11:44	426	12:24	386	13:04	346	13:44	306	14:24	266	15:04	226
11:45	425	12:25	385	13:05	345	13:45	305	14:25	265	15:05	225
11:46	424	12:26	384	13:06	344	13:46	304	14:26	264	15:06	224
11:47	423	12:27	383	13:07	343	13:47	303	14:27	263	15:07	223
11:48	422	12:28	382	13:08	342	13:48	302	14:28	262	15:08	222
11:49	421	12:29	381	13:09	341	13:49	301	14:29	261	15:09	221

TIME	PTS	TIME	PTS	TIME	PTS	TIME	PTS	TIME	PTS	TIME	PTS
15:10	220	15:50	180	16:30	140	17:10	100	17:50	60	18:30	20
15:11	219	15:51	179	16:31	139	17:11	99	17:51	59	18:31	19
15:12	218	15:52	178	16:32	138	17:12	98	17:52	58	18:32	18
15:13	217	15:53	177	16:33	137	17:13	97	17:53	57	18:33	17
15:14	216	15:54	176	16:34	136	17:14	96	17:54	56	18:34	16
15:15	215	15:55	175	16:35	135	17:15	95	17:55	55	18:35	15
15:16	214	15:56	174	16:36	134	17:16	94	17:56	54	18:36	14
15:17	213	15:57	173	16:37	133	17:17	93	17:57	53	18:37	13
15:18	212	15:58	172	16:38	132	17:18	92	17:58	52	18:38	12
15:19	211	15:59	171	16:39	131	17:19	91	17:59	51	18:39	11
15:20	210	16:00	170	16:40	130	17:20	90	18:00	50	18:40	10
15:21	209	16:01	169	16:41	129	17:21	89	18:01	49	18:41	9
15:22	208	16:02	168	16:42	128	17:22	88	18:02	48	18:42	8
15:23	207	16:03	167	16:43	127	17:23	87	18:03	47	18:43	7
15:24	206	16:04	166	16:44	126	17:24	86	18:04	46	18:44	6
15:25	205	16:05	165	16:45	125	17:25	85	18:05	45	18:45	5
15:26	204	16:06	164	16:46	124	17:26	84	18:06	44	18:46	4
15:27	203	16:07	163	16:47	123	17:27	83	18:07	43	18:47	3
15:28	202	16:08	162	16:48	122	17:28	82	18:08	42	18:48	2
15:29	201	16:09	161	16:49	121	17:29	81	18:09	41	18:49	1
15:30	200	16:10	160	16:50	120	17:30	80	18:10	40	18:50	0
15:31	199	16:11	159	16:51	119	17:31	79	18:11	39		
15:32	198	16:12	158	16:52	118	17:32	78	18:12	38		
15:33	197	16:13	157	16:53	117	17:33	77	18:13	37		
15:34	196	16:14	156	16:54	116	17:34	76	18:14	36		
15:35	195	16:15	155	16:55	115	17:35	75	18:15	35		
15:36	194	16:16	154	16:56	114	17:36	74	18:16	34		
15:37	193	16:17	153	16:57	113	17:37	73	18:17	33		
15:38	192	16:18	152	16:58	112	17:38	72	18:18	32		
15:39	191	16:19	151	16:59	111	17:39	71	18:19	31		
15:40	190	16:20	150	17:00	110	17:40	70	18:20	30		
15:41	189	16:21	149	17:01	109	17:41	69	18:21	29		
15:42	188	16:22	148	17:02	108	17:42	68	18:22	28		
15:43	187	16:23	147	17:03	107	17:43	67	18:23	27		
15:44	186	16:24	146	17:04	106	17:44	66	18:24	26		
15:45	185	16:25	145	17:05	105	17:45	65	18:25	25		
15:46	184	16:26	144	17:06	104	17:46	64	18:26	24		
15:47	183	16:27	143	17:07	103	17:47	63	18:27	23		
15:48	182	16:28	142	17:08	102	17:48	62	18:28	22		
15:49	181	16:29	141	17:09	101	17:49	61	18:29	21		



**POINTS TABLE
LASER RUN**

Appendix 5B3

**Individual Boys &
Girls: U15**

Relay: U15

TIME	PTS	TIME	PTS	TIME	PTS	TIME	PTS	TIME	PTS	TIME	PTS
04:20	700	05:00	660	05:40	620	06:20	580	07:00	540	07:40	500
04:21	699	05:01	659	05:41	619	06:21	579	07:01	539	07:41	499
04:22	698	05:02	658	05:42	618	06:22	578	07:02	538	07:42	498
04:23	697	05:03	657	05:43	617	06:23	577	07:03	537	07:43	497
04:24	696	05:04	656	05:44	616	06:24	576	07:04	536	07:44	496
04:25	695	05:05	655	05:45	615	06:25	575	07:05	535	07:45	495
04:26	694	05:06	654	05:46	614	06:26	574	07:06	534	07:46	494
04:27	693	05:07	653	05:47	613	06:27	573	07:07	533	07:47	493
04:28	692	05:08	652	05:48	612	06:28	572	07:08	532	07:48	492
04:29	691	05:09	651	05:49	611	06:29	571	07:09	531	07:49	491
04:30	690	05:10	650	05:50	610	06:30	570	07:10	530	07:50	490
04:31	689	05:11	649	05:51	609	06:31	569	07:11	529	07:51	489
04:32	688	05:12	648	05:52	608	06:32	568	07:12	528	07:52	488
04:33	687	05:13	647	05:53	607	06:33	567	07:13	527	07:53	487
04:34	686	05:14	646	05:54	606	06:34	566	07:14	526	07:54	486
04:35	685	05:15	645	05:55	605	06:35	565	07:15	525	07:55	485
04:36	684	05:16	644	05:56	604	06:36	564	07:16	524	07:56	484
04:37	683	05:17	643	05:57	603	06:37	563	07:17	523	07:57	483
04:38	682	05:18	642	05:58	602	06:38	562	07:18	522	07:58	482
04:39	681	05:19	641	05:59	601	06:39	561	07:19	521	07:59	481
04:40	680	05:20	640	06:00	600	06:40	560	07:20	520	08:00	480
04:41	679	05:21	639	06:01	599	06:41	559	07:21	519	08:01	479
04:42	678	05:22	638	06:02	598	06:42	558	07:22	518	08:02	478
04:43	677	05:23	637	06:03	597	06:43	557	07:23	517	08:03	477
04:44	676	05:24	636	06:04	596	06:44	556	07:24	516	08:04	476
04:45	675	05:25	635	06:05	595	06:45	555	07:25	515	08:05	475
04:46	674	05:26	634	06:06	594	06:46	554	07:26	514	08:06	474
04:47	673	05:27	633	06:07	593	06:47	553	07:27	513	08:07	473
04:48	672	05:28	632	06:08	592	06:48	552	07:28	512	08:08	472
04:49	671	05:29	631	06:09	591	06:49	551	07:29	511	08:09	471
04:50	670	05:30	630	06:10	590	06:50	550	07:30	510	08:10	470
04:51	669	05:31	629	06:11	589	06:51	549	07:31	509	08:11	469
04:52	668	05:32	628	06:12	588	06:52	548	07:32	508	08:12	468
04:53	667	05:33	627	06:13	587	06:53	547	07:33	507	08:13	467
04:54	666	05:34	626	06:14	586	06:54	546	07:34	506	08:14	466
04:55	665	05:35	625	06:15	585	06:55	545	07:35	505	08:15	465
04:56	664	05:36	624	06:16	584	06:56	544	07:36	504	08:16	464
04:57	663	05:37	623	06:17	583	06:57	543	07:37	503	08:17	463
04:58	662	05:38	622	06:18	582	06:58	542	07:38	502	08:18	462
04:59	661	05:39	621	06:19	581	06:59	541	07:39	501	08:19	461

TIME	PTS	TIME	PTS	TIME	PTS	TIME	PTS	TIME	PTS	TIME	PTS
08:20	460	09:00	420	09:40	380	10:20	340	11:00	300	11:40	260
08:21	459	09:01	419	09:41	379	10:21	339	11:01	299	11:41	259
08:22	458	09:02	418	09:42	378	10:22	338	11:02	298	11:42	258
08:23	457	09:03	417	09:43	377	10:23	337	11:03	297	11:43	257
08:24	456	09:04	416	09:44	376	10:24	336	11:04	296	11:44	256
08:25	455	09:05	415	09:45	375	10:25	335	11:05	295	11:45	255
08:26	454	09:06	414	09:46	374	10:26	334	11:06	294	11:46	254
08:27	453	09:07	413	09:47	373	10:27	333	11:07	293	11:47	253
08:28	452	09:08	412	09:48	372	10:28	332	11:08	292	11:48	252
08:29	451	09:09	411	09:49	371	10:29	331	11:09	291	11:49	251
08:30	450	09:10	410	09:50	370	10:30	330	11:10	290	11:50	250
08:31	449	09:11	409	09:51	369	10:31	329	11:11	289	11:51	249
08:32	448	09:12	408	09:52	368	10:32	328	11:12	288	11:52	248
08:33	447	09:13	407	09:53	367	10:33	327	11:13	287	11:53	247
08:34	446	09:14	406	09:54	366	10:34	326	11:14	286	11:54	246
08:35	445	09:15	405	09:55	365	10:35	325	11:15	285	11:55	245
08:36	444	09:16	404	09:56	364	10:36	324	11:16	284	11:56	244
08:37	443	09:17	403	09:57	363	10:37	323	11:17	283	11:57	243
08:38	442	09:18	402	09:58	362	10:38	322	11:18	282	11:58	242
08:39	441	09:19	401	09:59	361	10:39	321	11:19	281	11:59	241
08:40	440	09:20	400	10:00	360	10:40	320	11:20	280	12:00	240
08:41	439	09:21	399	10:01	359	10:41	319	11:21	279	12:01	239
08:42	438	09:22	398	10:02	358	10:42	318	11:22	278	12:02	238
08:43	437	09:23	397	10:03	357	10:43	317	11:23	277	12:03	237
08:44	436	09:24	396	10:04	356	10:44	316	11:24	276	12:04	236
08:45	435	09:25	395	10:05	355	10:45	315	11:25	275	12:05	235
08:46	434	09:26	394	10:06	354	10:46	314	11:26	274	12:06	234
08:47	433	09:27	393	10:07	353	10:47	313	11:27	273	12:07	233
08:48	432	09:28	392	10:08	352	10:48	312	11:28	272	12:08	232
08:49	431	09:29	391	10:09	351	10:49	311	11:29	271	12:09	231
08:50	430	09:30	390	10:10	350	10:50	310	11:30	270	12:10	230
08:51	429	09:31	389	10:11	349	10:51	309	11:31	269	12:11	229
08:52	428	09:32	388	10:12	348	10:52	308	11:32	268	12:12	228
08:53	427	09:33	387	10:13	347	10:53	307	11:33	267	12:13	227
08:54	426	09:34	386	10:14	346	10:54	306	11:34	266	12:14	226
08:55	425	09:35	385	10:15	345	10:55	305	11:35	265	12:15	225
08:56	424	09:36	384	10:16	344	10:56	304	11:36	264	12:16	224
08:57	423	09:37	383	10:17	343	10:57	303	11:37	263	12:17	223
08:58	422	09:38	382	10:18	342	10:58	302	11:38	262	12:18	222
08:59	421	09:39	381	10:19	341	10:59	301	11:39	261	12:19	221



TIME	PTS	TIME	PTS	TIME	PTS	TIME	PTS	TIME	PTS	TIME	PTS
12:20	220	13:00	180	13:40	140	14:20	100	15:00	60	15:40	20
12:21	219	13:01	179	13:41	139	14:21	99	15:01	59	15:41	19
12:22	218	13:02	178	13:42	138	14:22	98	15:02	58	15:42	18
12:23	217	13:03	177	13:43	137	14:23	97	15:03	57	15:43	17
12:24	216	13:04	176	13:44	136	14:24	96	15:04	56	15:44	16
12:25	215	13:05	175	13:45	135	14:25	95	15:05	55	15:45	15
12:26	214	13:06	174	13:46	134	14:26	94	15:06	54	15:46	14
12:27	213	13:07	173	13:47	133	14:27	93	15:07	53	15:47	13
12:28	212	13:08	172	13:48	132	14:28	92	15:08	52	15:48	12
12:29	211	13:09	171	13:49	131	14:29	91	15:09	51	15:49	11
12:30	210	13:10	170	13:50	130	14:30	90	15:10	50	15:50	10
12:31	209	13:11	169	13:51	129	14:31	89	15:11	49	15:51	9
12:32	208	13:12	168	13:52	128	14:32	88	15:12	48	15:52	8
12:33	207	13:13	167	13:53	127	14:33	87	15:13	47	15:53	7
12:34	206	13:14	166	13:54	126	14:34	86	15:14	46	15:54	6
12:35	205	13:15	165	13:55	125	14:35	85	15:15	45	15:55	5
12:36	204	13:16	164	13:56	124	14:36	84	15:16	44	15:56	4
12:37	203	13:17	163	13:57	123	14:37	83	15:17	43	15:57	3
12:38	202	13:18	162	13:58	122	14:38	82	15:18	42	15:58	2
12:39	201	13:19	161	13:59	121	14:39	81	15:19	41	15:59	1
12:40	200	13:20	160	14:00	120	14:40	80	15:20	40	16:00	0
12:41	199	13:21	159	14:01	119	14:41	79	15:21	39		
12:42	198	13:22	158	14:02	118	14:42	78	15:22	38		
12:43	197	13:23	157	14:03	117	14:43	77	15:23	37		
12:44	196	13:24	156	14:04	116	14:44	76	15:24	36		
12:45	195	13:25	155	14:05	115	14:45	75	15:25	35		
12:46	194	13:26	154	14:06	114	14:46	74	15:26	34		
12:47	193	13:27	153	14:07	113	14:47	73	15:27	33		
12:48	192	13:28	152	14:08	112	14:48	72	15:28	32		
12:49	191	13:29	151	14:09	111	14:49	71	15:29	31		
12:50	190	13:30	150	14:10	110	14:50	70	15:30	30		
12:51	189	13:31	149	14:11	109	14:51	69	15:31	29		
12:52	188	13:32	148	14:12	108	14:52	68	15:32	28		
12:53	187	13:33	147	14:13	107	14:53	67	15:33	27		
12:54	186	13:34	146	14:14	106	14:54	66	15:34	26		
12:55	185	13:35	145	14:15	105	14:55	65	15:35	25		
12:56	184	13:36	144	14:16	104	14:56	64	15:36	24		
12:57	183	13:37	143	14:17	103	14:57	63	15:37	23		
12:58	182	13:38	142	14:18	102	14:58	62	15:38	22		
12:59	181	13:39	141	14:19	101	14:59	61	15:39	21		

**POINTS TABLE
LASER RUN**

Appendix 5B4

**Individual Boys &
Girls: U13**

Relay: U11 & 9

TIME	PTS	TIME	PTS	TIME	PTS	TIME	PTS	TIME	PTS	TIME	PTS
<u>02:00</u>	700	<u>02:40</u>	660	<u>03:20</u>	620	<u>04:00</u>	580	<u>04:40</u>	540	<u>05:20</u>	500
02:01	699	02:41	659	03:21	619	04:01	579	04:41	539	05:21	499
02:02	698	02:42	658	03:22	618	04:02	578	04:42	538	05:22	498
02:03	697	02:43	657	03:23	617	04:03	577	04:43	537	05:23	497
02:04	696	02:44	656	03:24	616	04:04	576	04:44	536	05:24	496
02:05	695	02:45	655	03:25	615	04:05	575	04:45	535	05:25	495
02:06	694	02:46	654	03:26	614	04:06	574	04:46	534	05:26	494
02:07	693	02:47	653	03:27	613	04:07	573	04:47	533	05:27	493
02:08	692	02:48	652	03:28	612	04:08	572	04:48	532	05:28	492
02:09	691	02:49	651	03:29	611	04:09	571	04:49	531	05:29	491
<u>02:10</u>	690	<u>02:50</u>	650	<u>03:30</u>	610	<u>04:10</u>	570	<u>04:50</u>	530	<u>05:30</u>	490
02:11	689	02:51	649	03:31	609	04:11	569	04:51	529	05:31	489
02:12	688	02:52	648	03:32	608	04:12	568	04:52	528	05:32	488
02:13	687	02:53	647	03:33	607	04:13	567	04:53	527	05:33	487
02:14	686	02:54	646	03:34	606	04:14	566	04:54	526	05:34	486
02:15	685	02:55	645	03:35	605	04:15	565	04:55	525	05:35	485
02:16	684	02:56	644	03:36	604	04:16	564	04:56	524	05:36	484
02:17	683	02:57	643	03:37	603	04:17	563	04:57	523	05:37	483
02:18	682	02:58	642	03:38	602	04:18	562	04:58	522	05:38	482
02:19	681	02:59	641	03:39	601	04:19	561	04:59	521	05:39	481
<u>02:20</u>	680	<u>03:00</u>	640	<u>03:40</u>	600	<u>04:20</u>	560	<u>05:00</u>	520	<u>05:40</u>	480
02:21	679	03:01	639	03:41	599	04:21	559	05:01	519	05:41	479
02:22	678	03:02	638	03:42	598	04:22	558	05:02	518	05:42	478
02:23	677	03:03	637	03:43	597	04:23	557	05:03	517	05:43	477
02:24	676	03:04	636	03:44	596	04:24	556	05:04	516	05:44	476
02:25	675	03:05	635	03:45	595	04:25	555	05:05	515	05:45	475
02:26	674	03:06	634	03:46	594	04:26	554	05:06	514	05:46	474
02:27	673	03:07	633	03:47	593	04:27	553	05:07	513	05:47	473
02:28	672	03:08	632	03:48	592	04:28	552	05:08	512	05:48	472
02:29	671	03:09	631	03:49	591	04:29	551	05:09	511	05:49	471
<u>02:30</u>	670	<u>03:10</u>	630	<u>03:50</u>	590	<u>04:30</u>	550	<u>05:10</u>	510	<u>05:50</u>	470
02:31	669	03:11	629	03:51	589	04:31	549	05:11	509	05:51	469
02:32	668	03:12	628	03:52	588	04:32	548	05:12	508	05:52	468
02:33	667	03:13	627	03:53	587	04:33	547	05:13	507	05:53	467
02:34	666	03:14	626	03:54	586	04:34	546	05:14	506	05:54	466
02:35	665	03:15	625	03:55	585	04:35	545	05:15	505	05:55	465
02:36	664	03:16	624	03:56	584	04:36	544	05:16	504	05:56	464
02:37	663	03:17	623	03:57	583	04:37	543	05:17	503	05:57	463
02:38	662	03:18	622	03:58	582	04:38	542	05:18	502	05:58	462
02:39	661	03:19	621	03:59	581	04:39	541	05:19	501	05:59	461



TIME	PTS	TIME	PTS	TIME	PTS	TIME	PTS	TIME	PTS	TIME	PTS
<u>06:00</u>	460	<u>06:40</u>	420	<u>07:20</u>	380	<u>08:00</u>	340	<u>08:40</u>	300	<u>09:20</u>	260
06:01	459	06:41	419	07:21	379	08:01	339	08:41	299	09:21	259
06:02	458	06:42	418	07:22	378	08:02	338	08:42	298	09:22	258
06:03	457	06:43	417	07:23	377	08:03	337	08:43	297	09:23	257
06:04	456	06:44	416	07:24	376	08:04	336	08:44	296	09:24	256
06:05	455	06:45	415	07:25	375	08:05	335	08:45	295	09:25	255
06:06	454	06:46	414	07:26	374	08:06	334	08:46	294	09:26	254
06:07	453	06:47	413	07:27	373	08:07	333	08:47	293	09:27	253
06:08	452	06:48	412	07:28	372	08:08	332	08:48	292	09:28	252
06:09	451	06:49	411	07:29	371	08:09	331	08:49	291	09:29	251
<u>06:10</u>	450	<u>06:50</u>	410	<u>07:30</u>	370	<u>08:10</u>	330	<u>08:50</u>	290	<u>09:30</u>	250
06:11	449	06:51	409	07:31	369	08:11	329	08:51	289	09:31	249
06:12	448	06:52	408	07:32	368	08:12	328	08:52	288	09:32	248
06:13	447	06:53	407	07:33	367	08:13	327	08:53	287	09:33	247
06:14	446	06:54	406	07:34	366	08:14	326	08:54	286	09:34	246
06:15	445	06:55	405	07:35	365	08:15	325	08:55	285	09:35	245
06:16	444	06:56	404	07:36	364	08:16	324	08:56	284	09:36	244
06:17	443	06:57	403	07:37	363	08:17	323	08:57	283	09:37	243
06:18	442	06:58	402	07:38	362	08:18	322	08:58	282	09:38	242
06:19	441	06:59	401	07:39	361	08:19	321	08:59	281	09:39	241
<u>06:20</u>	440	<u>07:00</u>	400	<u>07:40</u>	360	<u>08:20</u>	320	<u>09:00</u>	280	<u>09:40</u>	240
06:21	439	07:01	399	07:41	359	08:21	319	09:01	279	09:41	239
06:22	438	07:02	398	07:42	358	08:22	318	09:02	278	09:42	238
06:23	437	07:03	397	07:43	357	08:23	317	09:03	277	09:43	237
06:24	436	07:04	396	07:44	356	08:24	316	09:04	276	09:44	236
06:25	435	07:05	395	07:45	355	08:25	315	09:05	275	09:45	235
06:26	434	07:06	394	07:46	354	08:26	314	09:06	274	09:46	234
06:27	433	07:07	393	07:47	353	08:27	313	09:07	273	09:47	233
06:28	432	07:08	392	07:48	352	08:28	312	09:08	272	09:48	232
06:29	431	07:09	391	07:49	351	08:29	311	09:09	271	09:49	231
<u>06:30</u>	430	<u>07:10</u>	390	<u>07:50</u>	350	<u>08:30</u>	310	<u>09:10</u>	270	<u>09:50</u>	230
06:31	429	07:11	389	07:51	349	08:31	309	09:11	269	09:51	229
06:32	428	07:12	388	07:52	348	08:32	308	09:12	268	09:52	228
06:33	427	07:13	387	07:53	347	08:33	307	09:13	267	09:53	227
06:34	426	07:14	386	07:54	346	08:34	306	09:14	266	09:54	226
06:35	425	07:15	385	07:55	345	08:35	305	09:15	265	09:55	225
06:36	424	07:16	384	07:56	344	08:36	304	09:16	264	09:56	224
06:37	423	07:17	383	07:57	343	08:37	303	09:17	263	09:57	223
06:38	422	07:18	382	07:58	342	08:38	302	09:18	262	09:58	222
06:39	421	07:19	381	07:59	341	08:39	301	09:19	261	09:59	221

TIME	PTS	TIME	PTS	TIME	PTS	TIME	PTS	TIME	PTS	TIME	PTS
<u>10:00</u>	220	<u>10:40</u>	180	<u>11:20</u>	140	<u>12:00</u>	100	<u>12:40</u>	60	<u>13:20</u>	20
10:01	219	10:41	179	11:21	139	12:01	99	12:41	59	13:21	19
10:02	218	10:42	178	11:22	138	12:02	98	12:42	58	13:22	18
10:03	217	10:43	177	11:23	137	12:03	97	12:43	57	13:23	17
10:04	216	10:44	176	11:24	136	12:04	96	12:44	56	13:24	16
10:05	215	10:45	175	11:25	135	12:05	95	12:45	55	13:25	15
10:06	214	10:46	174	11:26	134	12:06	94	12:46	54	13:26	14
10:07	213	10:47	173	11:27	133	12:07	93	12:47	53	13:27	13
10:08	212	10:48	172	11:28	132	12:08	92	12:48	52	13:28	12
10:09	211	10:49	171	11:29	131	12:09	91	12:49	51	13:29	11
<u>10:10</u>	210	<u>10:50</u>	170	<u>11:30</u>	130	<u>12:10</u>	90	<u>12:50</u>	50	<u>13:30</u>	10
10:11	209	10:51	169	11:31	129	12:11	89	12:51	49	13:31	9
10:12	208	10:52	168	11:32	128	12:12	88	12:52	48	13:32	8
10:13	207	10:53	167	11:33	127	12:13	87	12:53	47	13:33	7
10:14	206	10:54	166	11:34	126	12:14	86	12:54	46	13:34	6
10:15	205	10:55	165	11:35	125	12:15	85	12:55	45	13:35	5
10:16	204	10:56	164	11:36	124	12:16	84	12:56	44	13:36	4
10:17	203	10:57	163	11:37	123	12:17	83	12:57	43	13:37	3
10:18	202	10:58	162	11:38	122	12:18	82	12:58	42	13:38	2
10:19	201	10:59	161	11:39	121	12:19	81	12:59	41	13:39	1
<u>10:20</u>	200	<u>11:00</u>	160	<u>11:40</u>	120	<u>12:20</u>	80	<u>13:00</u>	40	<u>13:40</u>	0
10:21	199	11:01	159	11:41	119	12:21	79	13:01	39		
10:22	198	11:02	158	11:42	118	12:22	78	13:02	38		
10:23	197	11:03	157	11:43	117	12:23	77	13:03	37		
10:24	196	11:04	156	11:44	116	12:24	76	13:04	36		
10:25	195	11:05	155	11:45	115	12:25	75	13:05	35		
10:26	194	11:06	154	11:46	114	12:26	74	13:06	34		
10:27	193	11:07	153	11:47	113	12:27	73	13:07	33		
10:28	192	11:08	152	11:48	112	12:28	72	13:08	32		
10:29	191	11:09	151	11:49	111	12:29	71	13:09	31		
<u>10:30</u>	190	<u>11:10</u>	150	<u>11:50</u>	110	<u>12:30</u>	70	<u>13:10</u>	30		
10:31	189	11:11	149	11:51	109	12:31	69	13:11	29		
10:32	188	11:12	148	11:52	108	12:32	68	13:12	28		
10:33	187	11:13	147	11:53	107	12:33	67	13:13	27		
10:34	186	11:14	146	11:54	106	12:34	66	13:14	26		
10:35	185	11:15	145	11:55	105	12:35	65	13:15	25		
10:36	184	11:16	144	11:56	104	12:36	64	13:16	24		
10:37	183	11:17	143	11:57	103	12:37	63	13:17	23		
10:38	182	11:18	142	11:58	102	12:38	62	13:18	22		
10:39	181	11:19	141	11:59	101	12:39	61	13:19	21		



**POINTS TABLE
LASER RUN**

Appendix 5B5

**Individual Boys &
Girls: U11 & 9**

TIME	PTS	TIME	PTS	TIME	PTS	TIME	PTS	TIME	PTS	TIME	PTS
00:40	700	01:20	660	02:00	620	02:40	580	03:20	540	04:00	500
00:41	699	01:21	659	02:01	619	02:41	579	03:21	539	04:01	499
00:42	698	01:22	658	02:02	618	02:42	578	03:22	538	04:02	498
00:43	697	01:23	657	02:03	617	02:43	577	03:23	537	04:03	497
00:44	696	01:24	656	02:04	616	02:44	576	03:24	536	04:04	496
00:45	695	01:25	655	02:05	615	02:45	575	03:25	535	04:05	495
00:46	694	01:26	654	02:06	614	02:46	574	03:26	534	04:06	494
00:47	693	01:27	653	02:07	613	02:47	573	03:27	533	04:07	493
00:48	692	01:28	652	02:08	612	02:48	572	03:28	532	04:08	492
00:49	691	01:29	651	02:09	611	02:49	571	03:29	531	04:09	491
00:50	690	01:30	650	02:10	610	02:50	570	03:30	530	04:10	490
00:51	689	01:31	649	02:11	609	02:51	569	03:31	529	04:11	489
00:52	688	01:32	648	02:12	608	02:52	568	03:32	528	04:12	488
00:53	687	01:33	647	02:13	607	02:53	567	03:33	527	04:13	487
00:54	686	01:34	646	02:14	606	02:54	566	03:34	526	04:14	486
00:55	685	01:35	645	02:15	605	02:55	565	03:35	525	04:15	485
00:56	684	01:36	644	02:16	604	02:56	564	03:36	524	04:16	484
00:57	683	01:37	643	02:17	603	02:57	563	03:37	523	04:17	483
00:58	682	01:38	642	02:18	602	02:58	562	03:38	522	04:18	482
00:59	681	01:39	641	02:19	601	02:59	561	03:39	521	04:19	481
01:00	680	01:40	640	02:20	600	03:00	560	03:40	520	04:20	480
01:01	679	01:41	639	02:21	599	03:01	559	03:41	519	04:21	479
01:02	678	01:42	638	02:22	598	03:02	558	03:42	518	04:22	478
01:03	677	01:43	637	02:23	597	03:03	557	03:43	517	04:23	477
01:04	676	01:44	636	02:24	596	03:04	556	03:44	516	04:24	476
01:05	675	01:45	635	02:25	595	03:05	555	03:45	515	04:25	475
01:06	674	01:46	634	02:26	594	03:06	554	03:46	514	04:26	474
01:07	673	01:47	633	02:27	593	03:07	553	03:47	513	04:27	473
01:08	672	01:48	632	02:28	592	03:08	552	03:48	512	04:28	472
01:09	671	01:49	631	02:29	591	03:09	551	03:49	511	04:29	471
01:10	670	01:50	630	02:30	590	03:10	550	03:50	510	04:30	470
01:11	669	01:51	629	02:31	589	03:11	549	03:51	509	04:31	469
01:12	668	01:52	628	02:32	588	03:12	548	03:52	508	04:32	468
01:13	667	01:53	627	02:33	587	03:13	547	03:53	507	04:33	467
01:14	666	01:54	626	02:34	586	03:14	546	03:54	506	04:34	466
01:15	665	01:55	625	02:35	585	03:15	545	03:55	505	04:35	465
01:16	664	01:56	624	02:36	584	03:16	544	03:56	504	04:36	464
01:17	663	01:57	623	02:37	583	03:17	543	03:57	503	04:37	463
01:18	662	01:58	622	02:38	582	03:18	542	03:58	502	04:38	462
01:19	661	01:59	621	02:39	581	03:19	541	03:59	501	04:39	461

TIME	PTS	TIME	PTS	TIME	PTS	TIME	PTS	TIME	PTS	TIME	PTS
04:40	460	05:20	420	06:00	380	06:40	340	07:20	300	08:00	260
04:41	459	05:21	419	06:01	379	06:41	339	07:21	299	08:01	259
04:42	458	05:22	418	06:02	378	06:42	338	07:22	298	08:02	258
04:43	457	05:23	417	06:03	377	06:43	337	07:23	297	08:03	257
04:44	456	05:24	416	06:04	376	06:44	336	07:24	296	08:04	256
04:45	455	05:25	415	06:05	375	06:45	335	07:25	295	08:05	255
04:46	454	05:26	414	06:06	374	06:46	334	07:26	294	08:06	254
04:47	453	05:27	413	06:07	373	06:47	333	07:27	293	08:07	253
04:48	452	05:28	412	06:08	372	06:48	332	07:28	292	08:08	252
04:49	451	05:29	411	06:09	371	06:49	331	07:29	291	08:09	251
04:50	450	05:30	410	06:10	370	06:50	330	07:30	290	08:10	250
04:51	449	05:31	409	06:11	369	06:51	329	07:31	289	08:11	249
04:52	448	05:32	408	06:12	368	06:52	328	07:32	288	08:12	248
04:53	447	05:33	407	06:13	367	06:53	327	07:33	287	08:13	247
04:54	446	05:34	406	06:14	366	06:54	326	07:34	286	08:14	246
04:55	445	05:35	405	06:15	365	06:55	325	07:35	285	08:15	245
04:56	444	05:36	404	06:16	364	06:56	324	07:36	284	08:16	244
04:57	443	05:37	403	06:17	363	06:57	323	07:37	283	08:17	243
04:58	442	05:38	402	06:18	362	06:58	322	07:38	282	08:18	242
04:59	441	05:39	401	06:19	361	06:59	321	07:39	281	08:19	241
05:00	440	05:40	400	06:20	360	07:00	320	07:40	280	08:20	240
05:01	439	05:41	399	06:21	359	07:01	319	07:41	279	08:21	239
05:02	438	05:42	398	06:22	358	07:02	318	07:42	278	08:22	238
05:03	437	05:43	397	06:23	357	07:03	317	07:43	277	08:23	237
05:04	436	05:44	396	06:24	356	07:04	316	07:44	276	08:24	236
05:05	435	05:45	395	06:25	355	07:05	315	07:45	275	08:25	235
05:06	434	05:46	394	06:26	354	07:06	314	07:46	274	08:26	234
05:07	433	05:47	393	06:27	353	07:07	313	07:47	273	08:27	233
05:08	432	05:48	392	06:28	352	07:08	312	07:48	272	08:28	232
05:09	431	05:49	391	06:29	351	07:09	311	07:49	271	08:29	231
05:10	430	05:50	390	06:30	350	07:10	310	07:50	270	08:30	230
05:11	429	05:51	389	06:31	349	07:11	309	07:51	269	08:31	229
05:12	428	05:52	388	06:32	348	07:12	308	07:52	268	08:32	228
05:13	427	05:53	387	06:33	347	07:13	307	07:53	267	08:33	227
05:14	426	05:54	386	06:34	346	07:14	306	07:54	266	08:34	226
05:15	425	05:55	385	06:35	345	07:15	305	07:55	265	08:35	225
05:16	424	05:56	384	06:36	344	07:16	304	07:56	264	08:36	224
05:17	423	05:57	383	06:37	343	07:17	303	07:57	263	08:37	223
05:18	422	05:58	382	06:38	342	07:18	302	07:58	262	08:38	222
05:19	421	05:59	381	06:39	341	07:19	301	07:59	261	08:39	221



TIME	PTS	TIME	PTS	TIME	PTS	TIME	PTS	TIME	PTS	TIME	PTS
<u>08:40</u>	220	<u>09:20</u>	180	<u>10:00</u>	140	<u>10:40</u>	100	<u>11:20</u>	60	<u>12:00</u>	20
08:41	219	09:21	179	10:01	139	10:41	99	11:21	59	12:01	19
08:42	218	09:22	178	10:02	138	10:42	98	11:22	58	12:02	18
08:43	217	09:23	177	10:03	137	10:43	97	11:23	57	12:03	17
08:44	216	09:24	176	10:04	136	10:44	96	11:24	56	12:04	16
08:45	215	09:25	175	10:05	135	10:45	95	11:25	55	12:05	15
08:46	214	09:26	174	10:06	134	10:46	94	11:26	54	12:06	14
08:47	213	09:27	173	10:07	133	10:47	93	11:27	53	12:07	13
08:48	212	09:28	172	10:08	132	10:48	92	11:28	52	12:08	12
08:49	211	09:29	171	10:09	131	10:49	91	11:29	51	12:09	11
<u>08:50</u>	210	<u>09:30</u>	170	<u>10:10</u>	130	<u>10:50</u>	90	<u>11:30</u>	50	<u>12:10</u>	10
08:51	209	09:31	169	10:11	129	10:51	89	11:31	49	12:11	9
08:52	208	09:32	168	10:12	128	10:52	88	11:32	48	12:12	8
08:53	207	09:33	167	10:13	127	10:53	87	11:33	47	12:13	7
08:54	206	09:34	166	10:14	126	10:54	86	11:34	46	12:14	6
08:55	205	09:35	165	10:15	125	10:55	85	11:35	45	12:15	5
08:56	204	09:36	164	10:16	124	10:56	84	11:36	44	12:16	4
08:57	203	09:37	163	10:17	123	10:57	83	11:37	43	12:17	3
08:58	202	09:38	162	10:18	122	10:58	82	11:38	42	12:18	2
08:59	201	09:39	161	10:19	121	10:59	81	11:39	41	12:19	1
<u>09:00</u>	200	<u>09:40</u>	160	<u>10:20</u>	120	<u>11:00</u>	80	<u>11:40</u>	40	<u>12:20</u>	0
09:01	199	09:41	159	10:21	119	11:01	79	11:41	39		
09:02	198	09:42	158	10:22	118	11:02	78	11:42	38		
09:03	197	09:43	157	10:23	117	11:03	77	11:43	37		
09:04	196	09:44	156	10:24	116	11:04	76	11:44	36		
09:05	195	09:45	155	10:25	115	11:05	75	11:45	35		
09:06	194	09:46	154	10:26	114	11:06	74	11:46	34		
09:07	193	09:47	153	10:27	113	11:07	73	11:47	33		
09:08	192	09:48	152	10:28	112	11:08	72	11:48	32		
09:09	191	09:49	151	10:29	111	11:09	71	11:49	31		
<u>09:10</u>	190	<u>09:50</u>	150	<u>10:30</u>	110	<u>11:10</u>	70	<u>11:50</u>	30		
09:11	189	09:51	149	10:31	109	11:11	69	11:51	29		
09:12	188	09:52	148	10:32	108	11:12	68	11:52	28		
09:13	187	09:53	147	10:33	107	11:13	67	11:53	27		
09:14	186	09:54	146	10:34	106	11:14	66	11:54	26		
09:15	185	09:55	145	10:35	105	11:15	65	11:55	25		
09:16	184	09:56	144	10:36	104	11:16	64	11:56	24		
09:17	183	09:57	143	10:37	103	11:17	63	11:57	23		
09:18	182	09:58	142	10:38	102	11:18	62	11:58	22		
09:19	181	09:59	141	10:39	101	11:19	61	11:59	21		

06

EVENT RULES



MASTERS

PART A

THE EVENT

1 GENERAL ASPECTS

- 1.1 Definition and Purpose
- 1.2 Application
- 1.3 Format
- 1.4 The Events

- 1.5 Masters Participation
- 1.6 Finance
- 1.7 Competition Authorities
- 1.8 Masters Conference
- 1.9 Masters Committee

2 COMPETITION RESULTS

- 2.1 Handicap system

- 2.2 Point Tables

MASTERS

PART A

THE EVENT

1. GENERAL ASPECTS

1.1 Definition and Purpose

The UIPM Masters Competitions Rules apply to all UIPM Masters Competitions, i.e. Masters World Championships or Masters Continental Championships.

1.2 Application

The UIPM Competition, Medical and Advertising and Media Rules are applicable to the UIPM Master Competitions and Championships as far as not specified differently in the following.

1.3 FORMAT AND AGE GROUPS

1.3.1

UIPM Masters Competitions Formats

In UIPM Masters Competitions there are two formats:

- i. UIPM Masters Pentathlon; and
- ii. UIPM Masters Tetrathlon

and four different events:

- i. Individual;
- ii. Relay;
- iii. Mixed Relay; and
- iv. Team.

1.3.2

Masters must provide a valid UIPM International License during official registration and not later than official technical meeting in order to be considered for Masters Pentathlon events..

1.3.3

UIPM Masters Pentathlon events consists of the following disciplines: swimming, fencing, riding (show jumping) and a combination of shooting and running (Laser Run). UIPM Masters Tetrathlon consists of the same disciplines without riding (show jumping).

1.3.4

Within Masters World Championships and Masters Continental Championships men and women are gender-separated into the following 10 years age groups: 30 – 39 years (30+), 40 – 49 years (40+), 50 – 59 years (50+), 60 – 69 (60+) years and 70+. Key date for classification into age groups is January 1st of the year of birth of each competitor.

1.3.5

An athlete can start in a lower age group with a reduction of handicap points limited to the highest level of handicap points applicable to the lower age group. The athlete has to announce their decision on the date of their official registration. It is not allowed to start in two age groups.

1.3.6

Once the official registration process is completed it is not possible to move to any other age group unless approved by the UIPM Technical Delegate at the Technical Meeting prior to the competition and according to the UIPM regulations.

1.3.7

A fencing age group must not exceed 36 athletes. In case of more than 36 age-grouped participants the local organising committee (LOC) can split Masters Pentathletes and Tetrathletes, men/women and age groups.

1.3.8

The Relay competition must be arranged in teams of two participants from the same nation, the Mixed Relay competition must be arranged in mixed teams of two participants (1 man/1 woman) from the same nation according to Rule 1.5.3.

1.3.9

For Team participation art. 1.5.2 applies



1.4 THE EVENTS

- 1.4.1** In Swimming the distance is 100m freestyle for age groups 30+,40+ and 50+ while is 50m for athletes aged 60+ and 70+.
- 1.4.2** Fencing competition format will be organised as round robin only and its classification will be used as reference for points conversions in order to progress into the next competition phase, whether Laser Run (if masters tetrathlon) or riding (if masters pentathlon).
- 1.4.3** Riding at Masters World Championships and Masters Continental Championships in each age group must be organised with 10 obstacles including 2 double combinations, all at a max height of 90cm.
- 1.4.4** Masters have to demonstrate their riding ability in the warm up arena within 20 minutes. The TD/ NTO, together with the Riding Director can exclude masters from the evaluation if they are not able to sufficiently control the allotted horse and show the necessary riding ability.
- 1.4.5** The plan of the riding course and a list of the horses must be available at the official Technical Meeting. The organisers can adapt the difficulty of the course to the quality and abilities of the horses to jump the course up to 3 times.
- 1.4.6** The Laser Run follows specific Masters requirements: age groups, adapted distances, lead times and point tables (see table hereunder and paragraphs 2.1.3 and 2.2). The Laser-Run with laser pistol shooting, must be organised at all UIPM sanctioned masters' competitions and according to the UIPM Laser Run rules. The shooting distance for men and women Masters 30+, 40+ and 50+ is 10 m. The shooting distance for men and women Masters 60+ and 70+ is 5 m.

Age Groups Men/Women	Start	Run +/-	Shoot Time Limit	Run	Shoot Time Limit	Run	Shoot Time Limit	Run	Shooting distance
30+; 40+; 50+	Handicap	20 m	50 Sec	600 m	50 Sec	600 m	50 Sec	600 m	10 m
60+; 70+	Handicap	20 m	50 Sec	600 m	50 Sec	600 m			5 m

- 1.4.7** The Running distances for Masters age groups 30-59 years 60+ and 70+ years are defined in table 2.2.1. The conditions and difficulties of the running course must be adapted to the age of the Masters. For the length of the running course a difference of +/- 5% (max. 100m) is tolerated. All leading athletes in each age group start together within their handicap start.

1.5 MASTERS PARTICIPATION

1.5.1 Individual Participation

- 1.5.1.1** Each National Federation, member of the UIPM, has the right to register an unlimited number of pentathletes and tetrathletes as from 30 years of age and for both genders. If the number of athletes exceeds the organiser's capacities, the organising committee has the right to limit the number of participants either by registration deadline or limited participants per nation. Participating athletes must specify on the entry form whether they start for Masters Tetrathlon or for Pentathlon. Active athletes who have participated in any UIPM Category "A" competitions within the last 12 months are not allowed to start in Masters World and Masters Continental Championships.
- 1.5.1.2** Participating Masters are divided into age groups defined under 1.3.3. If a single age group reaches the minimum number of three (3) athletes, the competition will be valid and conducted according to the regulations defined by UIPM Masters rules, including medal ceremonies and final individual rankings.

1.5.1.3 If in the age groups 30+ or 40+ the number of participants is less than three (3) competitors, these athletes will be assigned to the next higher age group and judged according to their new classification. If in the 50+ age group the number of athletes is below three (3), the athletes will compete in the 40+ age group. Athletes will keep the amount of handicap points earned according to their age. Neither ranking nor medals will be assigned nor awarded for the original age group.

1.5.1.4 If in either age group 60+ or 70+ the number of participants is less than three (3) competitors these athletes will compete together and judged according to their new classification, either 60+ in the higher age category or 70+ in the lower age category. Athletes will keep the amount of handicap points earned according to their age. Neither ranking nor medals will be assigned nor awarded for the original age group.

1.5.2 Team Participation

1.5.2.1 Teams are assigned in either of the two categories: below age 60 (30+) or above age 60 (60+). All nations participating with a team of at least three (3) athletes in each main category will be entered in the team event competition. Team results are decided according to UIPM Team Classification Rules.

1.5.2.2 Any team (either masters pentathlon, tetrathlon, men and/or, women) can be arranged within each age category (30+ or 60+).

1.5.2.3 There must be a minimum of three (3) teams in men's competitions and two (2) teams in women's competitions in order to have team classification, medals ceremony and final ranking.

1.5.3 Relay and Mixed Relay Participation

1.5.3.1 Relay and Mixed Relay teams are assigned in two categories (30+ and 60+) with separate classification, medals ceremonies and final rankings. 60+ athletes are allowed to start in the 30+ category. However, their handicap points will be limited at HC 59 years.

1.5.3.2 Relay and Mixed Relay team event needs a minimum entry of three (3) teams for the competition to take place and consequently be ranked.

1.6 FINANCE

1.6.1 The Local Organising Committee (LOC) must take care of hosting (lodging, meals, local transport) at reasonable cost level, affordable for the majority of the Masters community. In addition, the LOC must offer a low-cost solution (camping site or holiday camp) at a reasonable distance to the competition venue(s).

1.6.2 Within the bounds of possibility, the LOC should arrange a visitors' programme and provide social/cultural events.

1.6.3 The organiser is eligible to charge a starting fee for the Masters Pentathlon competition, which includes the costs for the Riding event and a lower fee for the Masters Tetrathlon competition.

1.7 COMPETITION AUTHORITIES

**1.7.1
Official Technical Meeting (TM)** Up to two persons from each participating nation are authorised to take part in the Technical Meeting.

**1.7.2
Jury of Appeal** For Masters World Championships and Masters Continental Championships UIPM Competition Rules 1.16.6 iii) applies for constitution of Jury of Appeal. For all other Masters competitions, the Jury of Appeal consists of three members. The chair is held by a member of the UIPM Masters Committee. The two other members are elected at the TM from amongst its members.



1.7.3 Discipline

All rules regarding disciplinary matters are described in the UIPM Competition Rules General Aspects and UIPM Code of Ethics.

1.8 MASTERS CONFERENCE

The schedule of each Masters World Championships (MWCH) must include a time reserved for the International Masters Conference. This conference should be held after the competition and/or before the final ceremony.

1.8.1

The International Masters Conference is composed as follows: two masters from each UIPM member federation and the members of the UIPM Masters Committee. The UIPM Executive Board is entitled to delegate persons to participate without right to vote. Further persons may be allowed by the Conference to participate as guests with no voting rights and as observers only. The chair is held by the chairperson of the UIPM Masters Committee.

1.8.2

The International Masters Conference assists the UIPM Executive Board on the assignment and organisation of the Masters World Championships and Masters Continental Championships. It accepts proposals and decides on the basis of the report submitted by the chairperson and members of the UIPM Masters Committee.

1.9 UIPM MASTERS COMMITTEE

1.9.1

The UIPM Masters' Committee is composed of 5 members of differing nationalities. During the Masters World Championship occurring prior to the relevant UIPM congress, active Masters present on site will elect amongst them the members of the Masters' Committee ensuring adequate gender representation. All active Master athletes are eligible and have the right to vote provided that they are present at the relevant Masters World Championship. The elected members elect among them a Chairperson for the Masters' Committee.

1.9.2

Masters Committee can organize their activities internally and set up meetings in any form (round tables, skype/internet, conference call) as and when required by its elected members in order to discuss any items that concerns the UIPM masters family and any of its members in order to agree on the items and further action plans.

2. COMPETITION RESULTS

2.1 Handicap system

2.1.1

The handicap system gives the chance to calculate and determine the winners in Masters Competitions within each age group, team and relay category. Handicap points in the form of bonus points are added directly to the competitor's score.

2.1.2

In Masters World Championships and Masters Continental Championships an age group winner for Modern Pentathlon and Tetrathlon will only be declared after the handicap points have been added to the competitor's total competition points.

2.1.3

In other masters' competitions, the handicap points are added to the score of the competitor's first discipline.

2.1.4

In Relay competitions, the handicap points have to be added according to number of competitors of each relay team upfront (sum of handicap points of each competitor divided by number of competitors per relay team) and this amount has to be added to the Relay score of each Relay team after the first discipline.

2.1.5 Points Table – Handicap system

Age	Points	Tetrathlon	Pentathlon	Age	Points	Tetrathlon	Pentathlon
30	10 x 5,00	-40	-50				
31	9 x 5,00	-36	-45				
32	8 x 5,00	-32	-40				
33	7 x 5,00	-28	-35				
34	6 x 5,00	-24	-30				
35	5 x 5,00	-20	-25				
36	4 x 5,00	-16	-20				
37	3 x 5,00	-12	-15				
38	2 x 5,00	-8	-10				
39	1 x 5,00	-4	-5				
40	0 x 0,00	0	0	60	30 x 5,00	120	150
41	11 x 0,25	2	3	61	31 x 5,25	130	163
42	12 x 0,50	5	6	62	32 x 5,50	141	176
43	13 x 0,75	8	10	63	33 x 5,75	152	190
44	14 x 1,00	11	14	64	34 x 6,00	163	204
45	15 x 1,25	15	19	65	35 x 6,25	175	219
46	16 x 1,50	19	24	66	36 x 6,50	187	234
47	17 x 1,75	24	30	67	37 x 6,75	200	250
48	18 x 2,00	29	36	68	38 x 7,00	213	266
49	19 x 2,25	34	43	69	39 x 7,25	226	283
50	20 x 2,50	40	50	70	40 x 7,50	240	300
51	21 x 2,75	46	58	71	41 x 7,50	246	308
52	22 x 3,00	53	66	72	42 x 7,50	252	315
53	23 x 3,25	60	75	73	43 x 7,50	258	323
54	24 x 3,50	67	84	74	44 x 7,50	264	330
55	25 x 3,75	75	94	75	45 x 7,50	270	338
56	26 x 4,00	83	104	76	46 x 7,50	276	345
57	27 x 4,25	92	115	77	47 x 7,50	282	353
58	28 x 4,50	101	126	78	48 x 7,50	288	360
59	29 x 4,75	110	138	79	49 x 7,50	294	368

* Handicap points table is subject for further research and evaluation at masters competitions between Nov 2021 – April 2022 and will be approved by the UIPM Executive Board in April 2022. [This phrase will be deleted in the final version of Masters Rules]



2.2 Point Tables

2.2.1

The point table for the Laser Run follows UIPM rules for the relevant age groups and events according to the following table:

	Age Groups 30+; 40+; 50+ Men; Women		Age Groups 60+; 70+ Men; Women	
	Individual	Relay	Individual	Relay
Competitors	1	2	1	2
Run	± 20 m	± 20 m	± 20 m	± 20 m
Shoot	5 Hits 50 Sec	5 Hits 50 Sec	5 Hits 50 Sec	5 Hits 50 Sec
Run	600 m	600 m	600 m	600 m
Shoot	5 Hits 50 Sec	5 Hits 50 Sec	5 Hits 50 Sec	5 Hits 50 Sec
Run	600 m	600 m	600 m	600 m
Shoot	5 Hits 50 Sec		5 Hits	
Run	600 m			
Distance	1800 m	1200 m	1200 m	1200 m
Repetitions		2		2
Tot. Distance	2400 m	3200 m	1200 m	1600 m
Time 500 Pts	11:30.0	15:30.0	7:00.0	15:30.0
Points/s	± 1	± 1	± 1	± 1
Shooting distance	10 m	10 m	5 m	5 m

2.2.2

The point table for Fencing is calculated as follows:

- Formula: 70% bouts won corresponds to 250 points.
Each victory over or below this number adds or deducts the amount of points assigned to the number of bouts. (See UIPM / 2. Event Rules Fencing / Appendix: 2A or table below)
- Example: 32 fencers = 31 bouts
250 points = 22 victories
± 1 victory = ± 7 points

Fencing									
Athletes	Hits	250	bouts	Vict.	Athletes	Hits	250	bouts	Vict.
36	1	25	35	6	19	2	25	36	6
35	1	24	34	6	18	2	24	34	6
34	1	23	33	7	17	2	22	32	7
33	1	22	32	7	16	2	21	30	7
32	1	22	31	7	15	2	20	28	8
31	1	21	30	7	14	2	18	26	8
30	1	20	29	8	13	2	17	24	8
29	1	20	28	8	12	2	15	22	9
28	1	19	27	8	11	2	14	20	9
27	1	18	26	8					
26	1	18	25	8					
25	1	17	24	8					
24	1	16	23	8					
23	1	15	22	9					
22	1	15	21	9					
21	1	14	20	9					
20	1	13	19	9					

2.2.3

The point table for Swimming is calculated as follows:

Gender	Age Group	Distance	Time for 250 Points	Points/0.5sec
Men	30+;40+;50+	100m	1:18,0	± 1
Women	30+;40+;50+	100m	1:30,0	± 1
Men	60+;70+	50m	0:38,0	± 1
Women	60+;70+	50m	0:43,0	± 1

For the purpose of calculating the score, times will be recorded in half seconds.

Fractions of second are not considered e.g.:

1:18.49 is recorded as 1:18.0

1:30.49 is recorded as 1:30.0

1:18.51 is recorded as 1:18.5

1:30.51 is recorded as 1:30.5

2.2.4

The point valuation for Riding is laid down in the UIPM Competition Rules for Riding.



2.2 Point Tables

SWIMMING POINT TABLE Women: 30+ / 40+ / 50+

MIN	PTS	MIN	PTS	MIN	PTS	MIN	PTS	MIN	PTS	MIN	PTS	MIN	PTS
01:05.0	300	01:26.5	257	01:48.0	214	02:09.5	171	02:31.0	128	02:52.5	85	03:14.0	42
01:05.5	299	01:27.0	256	01:48.5	213	<u>02:10.0</u>	170	02:31.5	127	02:53.0	84	03:14.5	41
01:06.0	298	01:27.5	255	01:49.0	212	02:10.5	169	02:32.0	126	02:53.5	83	<u>03:15.0</u>	40
01:06.5	297	01:28.0	254	01:49.5	211	02:11.0	168	02:32.5	125	02:54.0	82	03:15.5	39
01:07.0	296	01:28.5	253	<u>01:50.0</u>	210	02:11.5	167	02:33.0	124	02:54.5	81	03:16.0	38
01:07.5	295	01:29.0	252	01:50.5	209	02:12.0	166	02:33.5	123	<u>02:55.0</u>	80	03:16.5	37
01:08.0	294	01:29.5	251	01:51.0	208	02:12.5	165	02:34.0	122	02:55.5	79	03:17.0	36
01:08.5	293	<u>01:30.0</u>	250	01:51.5	207	02:13.0	164	02:34.5	121	02:56.0	78	03:17.5	35
01:09.0	292	01:30.5	249	01:52.0	206	02:13.5	163	<u>02:35.0</u>	120	02:56.5	77	03:18.0	34
01:09.5	291	01:31.0	248	01:52.5	205	02:14.0	162	02:35.5	119	02:57.0	76	03:18.5	33
<u>01:10.0</u>	290	01:31.5	247	01:53.0	204	02:14.5	161	02:36.0	118	02:57.5	75	03:19.0	32
01:10.5	289	01:32.0	246	01:53.5	203	<u>02:15.0</u>	160	02:36.5	117	02:58.0	74	03:19.5	31
01:11.0	288	01:32.5	245	01:54.0	202	02:15.5	159	02:37.0	116	02:58.5	73	<u>03:20.0</u>	30
01:11.5	287	01:33.0	244	01:54.5	201	02:16.0	158	02:37.5	115	02:59.0	72	03:20.5	29
01:12.0	286	01:33.5	243	<u>01:55.0</u>	200	02:16.5	157	02:38.0	114	02:59.5	71	03:21.0	28
01:12.5	285	01:34.0	242	01:55.5	199	02:17.0	156	02:38.5	113	<u>03:00.0</u>	70	03:21.5	27
01:13.0	284	01:34.5	241	01:56.0	198	02:17.5	155	02:39.0	112	03:00.5	69	03:22.0	26
01:13.5	283	<u>01:35.0</u>	240	01:56.5	197	02:18.0	154	02:39.5	111	03:01.0	68	03:22.5	25
01:14.0	282	01:35.5	239	01:57.0	196	02:18.5	153	<u>02:40.0</u>	110	03:01.5	67	03:23.0	24
01:14.5	281	01:36.0	238	01:57.5	195	02:19.0	152	02:40.5	109	03:02.0	66	03:23.5	23
<u>01:15.0</u>	280	01:36.5	237	01:58.0	194	02:19.5	151	02:41.0	108	03:02.5	65	03:24.0	22
01:15.5	279	01:37.0	236	01:58.5	193	<u>02:20.0</u>	150	02:41.5	107	03:03.0	64	03:24.5	21
01:16.0	278	01:37.5	235	01:59.0	192	02:20.5	149	02:42.0	106	03:03.5	63	<u>03:25.0</u>	20
01:16.5	277	01:38.0	234	01:59.5	191	02:21.0	148	02:42.5	105	03:04.0	62	03:25.5	19
01:17.0	276	01:38.5	233	<u>02:00.0</u>	190	02:21.5	147	02:43.0	104	03:04.5	61	03:26.0	18
01:17.5	275	01:39.0	232	02:00.5	189	02:22.0	146	02:43.5	103	<u>03:05.0</u>	60	03:26.5	17
01:18.0	274	01:39.5	231	02:01.0	188	02:22.5	145	02:44.0	102	03:05.5	59	03:27.0	16
01:18.5	273	<u>01:40.0</u>	230	02:01.5	187	02:23.0	144	02:44.5	101	03:06.0	58	03:27.5	15
01:19.0	272	01:40.5	229	02:02.0	186	02:23.5	143	<u>02:45.0</u>	100	03:06.5	57	03:28.0	14
01:19.5	271	01:41.0	228	02:02.5	185	02:24.0	142	02:45.5	99	03:07.0	56	03:28.5	13
<u>01:20.0</u>	270	01:41.5	227	02:03.0	184	02:24.5	141	02:46.0	98	03:07.5	55	03:29.0	12
01:20.5	269	01:42.0	226	02:03.5	183	<u>02:25.0</u>	140	02:46.5	97	03:08.0	54	03:29.5	11
01:21.0	268	01:42.5	225	02:04.0	182	02:25.5	139	02:47.0	96	03:08.5	53	<u>03:30.0</u>	10
01:21.5	267	01:43.0	224	02:04.5	181	02:26.0	138	02:47.5	95	03:09.0	52	03:30.5	9
01:22.0	266	01:43.5	223	<u>02:05.0</u>	180	02:26.5	137	02:48.0	94	03:09.5	51	03:31.0	8
01:22.5	265	01:44.0	222	02:05.5	179	02:27.0	136	02:48.5	93	<u>03:10.0</u>	50	03:31.5	7
01:23.0	264	01:44.5	221	02:06.0	178	02:27.5	135	02:49.0	92	03:10.5	49	03:32.0	6
01:23.5	263	<u>01:45.0</u>	220	02:06.5	177	02:28.0	134	02:49.5	91	03:11.0	48	03:32.5	5
01:24.0	262	01:45.5	219	02:07.0	176	02:28.5	133	<u>02:50.0</u>	90	03:11.5	47	03:33.0	4
01:24.5	261	01:46.0	218	02:07.5	175	02:29.0	132	02:50.5	89	03:12.0	46	03:33.5	3
<u>01:25.0</u>	260	01:46.5	217	02:08.0	174	02:29.5	131	02:51.0	88	03:12.5	45	03:34.0	2
01:25.5	259	01:47.0	216	02:08.5	173	<u>02:30.0</u>	130	02:51.5	87	03:13.0	44	03:34.5	1
01:26.0	258	01:47.5	215	02:09.0	172	02:30.5	129	02:52.0	86	03:13.5	43	<u>03:35.0</u>	0

2.2 Point Tables

SWIMMING POINT TABLE
Men: 30+ / 40+ / 50+

Min	pts	Min	pts	min	pts	min	pts	min	pts	min	pts	min	pts
00:50.0	306	01:12.0	262	01:34.0	218	01:56.0	174	02:18.0	130	<u>02:40.0</u>	86	03:02.0	42
00:50.5	305	01:12.5	261	01:34.5	217	01:56.5	173	02:18.5	129	02:40.5	85	03:02.5	41
00:51.0	304	01:13.0	260	<u>01:35.0</u>	216	01:57.0	172	02:19.0	128	02:41.0	84	03:03.0	40
00:51.5	303	01:13.5	259	01:35.5	215	01:57.5	171	02:19.5	127	02:41.5	83	03:03.5	39
00:52.0	302	01:14.0	258	01:36.0	214	01:58.0	170	<u>02:20.0</u>	126	02:42.0	82	03:04.0	38
00:52.5	301	01:14.5	257	01:36.5	213	01:58.5	169	02:20.5	125	02:42.5	81	03:04.5	37
00:53.0	300	01:15.0	256	01:37.0	212	01:59.0	168	02:21.0	124	02:43.0	80	<u>03:05.0</u>	36
00:53.5	299	01:15.5	255	01:37.5	211	01:59.5	167	02:21.5	123	02:43.5	79	03:05.5	35
00:54.0	298	01:16.0	254	01:38.0	210	<u>02:00.0</u>	166	02:22.0	122	02:44.0	78	03:06.0	34
00:54.5	297	01:16.5	253	01:38.5	209	02:00.5	165	02:22.5	121	02:44.5	77	03:06.5	33
<u>00:55.0</u>	296	01:17.0	252	01:39.0	208	02:01.0	164	02:23.0	120	<u>02:45.0</u>	76	03:07.0	32
00:55.5	295	01:17.5	251	01:39.5	207	02:01.5	163	02:23.5	119	02:45.5	75	03:07.5	31
00:56.0	294	<u>01:18.0</u>	250	01:40.0	206	02:02.0	162	02:24.0	118	02:46.0	74	03:08.0	30
00:56.5	293	01:18.5	249	01:40.5	205	02:02.5	161	02:24.5	117	02:46.5	73	03:08.5	29
00:57.0	292	01:19.0	248	01:41.0	204	02:03.0	160	<u>02:25.0</u>	116	02:47.0	72	03:09.0	28
00:57.5	291	01:19.5	247	01:41.5	203	02:03.5	159	02:25.5	115	02:47.5	71	03:09.5	27
00:58.0	290	<u>01:20.0</u>	246	01:42.0	202	02:04.0	158	02:26.0	114	02:48.0	70	<u>03:10.0</u>	26
00:58.5	289	01:20.5	245	01:42.5	201	02:04.5	157	02:26.5	113	02:48.5	69	03:10.5	25
00:59.0	288	01:21.0	244	01:43.0	200	02:05.0	156	02:27.0	112	02:49.0	68	03:11.0	24
00:59.5	287	01:21.5	243	01:43.5	199	02:05.5	155	02:27.5	111	02:49.5	67	03:11.5	23
<u>01:00.0</u>	286	01:22.0	242	01:44.0	198	02:06.0	154	02:28.0	110	<u>02:50.0</u>	66	03:12.0	22
01:00.5	285	01:22.5	241	01:44.5	197	02:06.5	153	02:28.5	109	02:50.5	65	03:12.5	21
01:01.0	284	01:23.0	240	<u>01:45.0</u>	196	02:07.0	152	02:29.0	108	02:51.0	64	03:13.0	20
01:01.5	283	01:23.5	239	01:45.5	195	02:07.5	151	02:29.5	107	02:51.5	63	03:13.5	19
01:02.0	282	01:24.0	238	01:46.0	194	02:08.0	150	02:30.0	106	02:52.0	62	03:14.0	18
01:02.5	281	01:24.5	237	01:46.5	193	02:08.5	149	02:30.5	105	02:52.5	61	03:14.5	17
01:03.0	280	<u>01:25.0</u>	236	01:47.0	192	02:09.0	148	02:31.0	104	02:53.0	60	<u>03:15.0</u>	16
01:03.5	279	01:25.5	235	01:47.5	191	02:09.5	147	02:31.5	103	02:53.5	59	03:15.5	15
01:04.0	278	01:26.0	234	01:48.0	190	<u>02:10.0</u>	146	02:32.0	102	02:54.0	58	03:16.0	14
01:04.5	277	01:26.5	233	01:48.5	189	02:10.5	145	02:32.5	101	02:54.5	57	03:16.5	13
<u>01:05.0</u>	276	01:27.0	232	01:49.0	188	02:11.0	144	02:33.0	100	02:55.0	56	03:17.0	12
01:05.5	275	01:27.5	231	01:49.5	187	02:11.5	143	02:33.5	99	02:55.5	55	03:17.5	11
01:06.0	274	01:28.0	230	<u>01:50.0</u>	186	02:12.0	142	02:34.0	98	02:56.0	54	03:18.0	10
01:06.5	273	01:28.5	229	01:50.5	185	02:12.5	141	02:34.5	97	02:56.5	53	03:18.5	9
01:07.0	272	01:29.0	228	01:51.0	184	02:13.0	140	<u>02:35.0</u>	96	02:57.0	52	03:19.0	8
01:07.5	271	01:29.5	227	01:51.5	183	02:13.5	139	02:35.5	95	02:57.5	51	03:19.5	7
01:08.0	270	<u>01:30.0</u>	226	01:52.0	182	02:14.0	138	02:36.0	94	02:58.0	50	03:20.0	6
01:08.5	269	01:30.5	225	01:52.5	181	02:14.5	137	02:36.5	93	02:58.5	49	03:20.5	5
01:09.0	268	01:31.0	224	01:53.0	180	<u>02:15.0</u>	136	02:37.0	92	02:59.0	48	03:21.0	4
01:09.5	267	01:31.5	223	01:53.5	179	02:15.5	135	02:37.5	91	02:59.5	47	03:21.5	3
<u>01:10.0</u>	266	01:32.0	222	01:54.0	178	02:16.0	134	02:38.0	90	<u>03:00.0</u>	46	03:22.0	2
01:10.5	265	01:32.5	221	01:54.5	177	02:16.5	133	02:38.5	89	03:00.5	45	03:22.5	1
01:11.0	264	01:33.0	220	<u>01:55.0</u>	176	02:17.0	132	02:39.0	88	03:01.0	44	03:23.0	0
01:11.5	263	01:33.5	219	01:55.5	175	02:17.5	131	02:39.5	87	03:01.5	43		



2.2 Point Tables

SWIMMING POINT TABLE Women: 60+ / 70+

min	pts	Min	pts	Min	pts	min	pts	min	pts	min	pts	min	pts
00:20.0	296	00:42.0	252	01:04.0	208	01:26.0	164	01:48.0	120	<u>02:10.0</u>	76	02:32.0	32
00:20.5	295	00:42.5	251	01:04.5	207	01:26.5	163	01:48.5	119	02:10.5	75	02:32.5	31
00:21.0	294	<u>00:43.0</u>	250	<u>01:05.0</u>	206	01:27.0	162	01:49.0	118	02:11.0	74	02:33.0	30
00:21.5	293	00:43.5	249	01:05.5	205	01:27.5	161	01:49.5	117	02:11.5	73	02:33.5	29
00:22.0	292	00:44.0	248	01:06.0	204	01:28.0	160	<u>01:50.0</u>	116	02:12.0	72	02:34.0	28
00:22.5	291	00:44.5	247	01:06.5	203	01:28.5	159	01:50.5	115	02:12.5	71	02:34.5	27
00:23.0	290	<u>00:45.0</u>	246	01:07.0	202	01:29.0	158	01:51.0	114	02:13.0	70	<u>02:35.0</u>	26
00:23.5	289	00:45.5	245	01:07.5	201	01:29.5	157	01:51.5	113	02:13.5	69	02:35.5	25
00:24.0	288	00:46.0	244	01:08.0	200	<u>01:30.0</u>	156	01:52.0	112	02:14.0	68	02:36.0	24
00:24.5	287	00:46.5	243	01:08.5	199	01:30.5	155	01:52.5	111	02:14.5	67	02:36.5	23
<u>00:25.0</u>	286	00:47.0	242	01:09.0	198	01:31.0	154	01:53.0	110	<u>02:15.0</u>	66	02:37.0	22
00:25.5	285	00:47.5	241	01:09.5	197	01:31.5	153	01:53.5	109	02:15.5	65	02:37.5	21
00:26.0	284	00:48.0	240	<u>01:10.0</u>	196	01:32.0	152	01:54.0	108	02:16.0	64	02:38.0	20
00:26.5	283	00:48.5	239	01:10.5	195	01:32.5	151	01:54.5	107	02:16.5	63	02:38.5	19
00:27.0	282	00:49.0	238	01:11.0	194	01:33.0	150	<u>01:55.0</u>	106	02:17.0	62	02:39.0	18
00:27.5	281	00:49.5	237	01:11.5	193	01:33.5	149	01:55.5	105	02:17.5	61	02:39.5	17
00:28.0	280	00:50.0	236	01:12.0	192	01:34.0	148	01:56.0	104	02:18.0	60	<u>02:40.0</u>	16
00:28.5	279	00:50.5	235	01:12.5	191	01:34.5	147	01:56.5	103	02:18.5	59	02:40.5	15
00:29.0	278	00:51.0	234	01:13.0	190	<u>01:35.0</u>	146	01:57.0	102	02:19.0	58	02:41.0	14
00:29.5	277	00:51.5	233	01:13.5	189	01:35.5	145	01:57.5	101	02:19.5	57	02:41.5	13
<u>00:30.0</u>	276	00:52.0	232	01:14.0	188	01:36.0	144	01:58.0	100	<u>02:20.0</u>	56	02:42.0	12
00:30.5	275	00:52.5	231	01:14.5	187	01:36.5	143	01:58.5	99	02:20.5	55	02:42.5	11
00:31.0	274	00:53.0	230	01:15.0	186	01:37.0	142	01:59.0	98	02:21.0	54	02:43.0	10
00:31.5	273	00:53.5	229	01:15.5	185	01:37.5	141	01:59.5	97	02:21.5	53	02:43.5	9
00:32.0	272	00:54.0	228	01:16.0	184	01:38.0	140	<u>02:00.0</u>	96	02:22.0	52	02:44.0	8
00:32.5	271	00:54.5	227	01:16.5	183	01:38.5	139	02:00.5	95	02:22.5	51	02:44.5	7
00:33.0	270	<u>00:55.0</u>	226	01:17.0	182	01:39.0	138	02:01.0	94	02:23.0	50	<u>02:45.0</u>	6
00:33.5	269	00:55.5	225	01:17.5	181	01:39.5	137	02:01.5	93	02:23.5	49	02:45.5	5
00:34.0	268	00:56.0	224	01:18.0	180	01:40.0	136	02:02.0	92	02:24.0	48	02:46.0	4
00:34.5	267	00:56.5	223	01:18.5	179	01:40.5	135	02:02.5	91	02:24.5	47	02:46.5	3
00:35.0	266	00:57.0	222	01:19.0	178	01:41.0	134	02:03.0	90	<u>02:25.0</u>	46	02:47.0	2
00:35.5	265	00:57.5	221	01:19.5	177	01:41.5	133	02:03.5	89	02:25.5	45	02:47.5	1
00:36.0	264	00:58.0	220	<u>01:20.0</u>	176	01:42.0	132	02:04.0	88	02:26.0	44	02:48.0	0
00:36.5	263	00:58.5	219	01:20.5	175	01:42.5	131	02:04.5	87	02:26.5	43		
00:37.0	262	00:59.0	218	01:21.0	174	01:43.0	130	02:05.0	86	02:27.0	42		
00:37.5	261	00:59.5	217	01:21.5	173	01:43.5	129	02:05.5	85	02:27.5	41		
00:38.0	260	<u>01:00.0</u>	216	01:22.0	172	01:44.0	128	02:06.0	84	02:28.0	40		
00:38.5	259	01:00.5	215	01:22.5	171	01:44.5	127	02:06.5	83	02:28.5	39		
00:39.0	258	01:01.0	214	01:23.0	170	<u>01:45.0</u>	126	02:07.0	82	02:29.0	38		
00:39.5	257	01:01.5	213	01:23.5	169	01:45.5	125	02:07.5	81	02:29.5	37		
00:40.0	256	01:02.0	212	01:24.0	168	01:46.0	124	02:08.0	80	02:30.0	36		
00:40.5	255	01:02.5	211	01:24.5	167	01:46.5	123	02:08.5	79	02:30.5	35		
00:41.0	254	01:03.0	210	<u>01:25.0</u>	166	01:47.0	122	02:09.0	78	02:31.0	34		
00:41.5	253	01:03.5	209	01:25.5	165	01:47.5	121	02:09.5	77	02:31.5	33		

2.2 Point Tables

SWIMMING POINT TABLE
Men: 60+ / 70+

min	pts	Min	pts	Min	pts	min	pts	min	pts	min	pts	min	pts
00:20.0	286	00:40.5	245	01:01.0	204	01:21.5	163	01:42.0	122	02:02.5	81	02:23.0	40
00:20.5	285	00:41.0	244	01:01.5	203	01:22.0	162	01:42.5	121	02:03.0	80	02:23.5	39
00:21.0	284	00:41.5	243	01:02.0	202	01:22.5	161	01:43.0	120	02:03.5	79	02:24.0	38
00:21.5	283	00:42.0	242	01:02.5	201	01:23.0	160	01:43.5	119	02:04.0	78	02:24.5	37
00:22.0	282	00:42.5	241	01:03.0	200	01:23.5	159	01:44.0	118	02:04.5	77	<u>02:25.0</u>	36
00:22.5	281	00:43.0	240	01:03.5	199	01:24.0	158	01:44.5	117	02:05.0	76	02:25.5	35
00:23.0	280	00:43.5	239	01:04.0	198	01:24.5	157	<u>01:45.0</u>	116	02:05.5	75	02:26.0	34
00:23.5	279	00:44.0	238	01:04.5	197	<u>01:25.0</u>	156	01:45.5	115	02:06.0	74	02:26.5	33
00:24.0	278	00:44.5	237	<u>01:05.0</u>	196	01:25.5	155	01:46.0	114	02:06.5	73	02:27.0	32
00:24.5	277	<u>00:45.0</u>	236	01:05.5	195	01:26.0	154	01:46.5	113	02:07.0	72	02:27.5	31
<u>00:25.0</u>	276	00:45.5	235	01:06.0	194	01:26.5	153	01:47.0	112	02:07.5	71	02:28.0	30
00:25.5	275	00:46.0	234	01:06.5	193	01:27.0	152	01:47.5	111	02:08.0	70	02:28.5	29
00:26.0	274	00:46.5	233	01:07.0	192	01:27.5	151	01:48.0	110	02:08.5	69	02:29.0	28
00:26.5	273	00:47.0	232	01:07.5	191	01:28.0	150	01:48.5	109	02:09.0	68	02:29.5	27
00:27.0	272	00:47.5	231	01:08.0	190	01:28.5	149	01:49.0	108	02:09.5	67	02:30.0	26
00:27.5	271	00:48.0	230	01:08.5	189	01:29.0	148	01:49.5	107	<u>02:10.0</u>	66	02:30.5	25
00:28.0	270	00:48.5	229	01:09.0	188	01:29.5	147	<u>01:50.0</u>	106	02:10.5	65	02:31.0	24
00:28.5	269	00:49.0	228	01:09.5	187	<u>01:30.0</u>	146	01:50.5	105	02:11.0	64	02:31.5	23
00:29.0	268	00:49.5	227	<u>01:10.0</u>	186	01:30.5	145	01:51.0	104	02:11.5	63	02:32.0	22
00:29.5	267	00:50.0	226	01:10.5	185	01:31.0	144	01:51.5	103	02:12.0	62	02:32.5	21
<u>00:30.0</u>	266	00:50.5	225	01:11.0	184	01:31.5	143	01:52.0	102	02:12.5	61	02:33.0	20
00:30.5	265	00:51.0	224	01:11.5	183	01:32.0	142	01:52.5	101	02:13.0	60	02:33.5	19
00:31.0	264	00:51.5	223	01:12.0	182	01:32.5	141	01:53.0	100	02:13.5	59	02:34.0	18
00:31.5	263	00:52.0	222	01:12.5	181	01:33.0	140	01:53.5	99	02:14.0	58	02:34.5	17
00:32.0	262	00:52.5	221	01:13.0	180	01:33.5	139	01:54.0	98	02:14.5	57	<u>02:35.0</u>	16
00:32.5	261	00:53.0	220	01:13.5	179	01:34.0	138	01:54.5	97	<u>02:15.0</u>	56	02:35.5	15
00:33.0	260	00:53.5	219	01:14.0	178	01:34.5	137	<u>01:55.0</u>	96	02:15.5	55	02:36.0	14
00:33.5	259	00:54.0	218	01:14.5	177	<u>01:35.0</u>	136	01:55.5	95	02:16.0	54	02:36.5	13
00:34.0	258	00:54.5	217	01:15.0	176	01:35.5	135	01:56.0	94	02:16.5	53	02:37.0	12
00:34.5	257	<u>00:55.0</u>	216	01:15.5	175	01:36.0	134	01:56.5	93	02:17.0	52	02:37.5	11
00:35.0	256	00:55.5	215	01:16.0	174	01:36.5	133	01:57.0	92	02:17.5	51	02:38.0	10
00:35.5	255	00:56.0	214	01:16.5	173	01:37.0	132	01:57.5	91	02:18.0	50	02:38.5	9
00:36.0	254	00:56.5	213	01:17.0	172	01:37.5	131	01:58.0	90	02:18.5	49	02:39.0	8
00:36.5	253	00:57.0	212	01:17.5	171	01:38.0	130	01:58.5	89	02:19.0	48	02:39.5	7
00:37.0	252	00:57.5	211	01:18.0	170	01:38.5	129	01:59.0	88	02:19.5	47	<u>02:40.0</u>	6
00:37.5	251	00:58.0	210	01:18.5	169	01:39.0	128	01:59.5	87	<u>02:20.0</u>	46	02:40.5	5
<u>00:38.0</u>	250	00:58.5	209	01:19.0	168	01:39.5	127	<u>02:00.0</u>	86	02:20.5	45	02:41.0	4
00:38.5	249	00:59.0	208	01:19.5	167	01:40.0	126	02:00.5	85	02:21.0	44	02:41.5	3
00:39.0	248	00:59.5	207	<u>01:20.0</u>	166	01:40.5	125	02:01.0	84	02:21.5	43	02:42.0	2
00:39.5	247	<u>01:00.0</u>	206	01:20.5	165	01:41.0	124	02:01.5	83	02:22.0	42	02:42.5	1
00:40.0	246	01:00.5	205	01:21.0	164	01:41.5	123	02:02.0	82	02:22.5	41	02:43.0	0



2.2 Point Tables

LASER RUN POINT TABLE

Individual Men / Women: 30+ / 40+ / 50+

time	pts	time	pts	time	pts	time	pts	time	pts	time	pts
09:50	600	10:30	560	11:10	520	11:50	480	12:30	440	13:10	400
09:51	599	10:31	559	11:11	519	11:51	479	12:31	439	13:11	399
09:52	598	10:32	558	11:12	518	11:52	478	12:32	438	13:12	398
09:53	597	10:33	557	11:13	517	11:53	477	12:33	437	13:13	397
09:54	596	10:34	556	11:14	516	11:54	476	12:34	436	13:14	396
09:55	595	10:35	555	11:15	515	11:55	475	12:35	435	13:15	395
09:56	594	10:36	554	11:16	514	11:56	474	12:36	434	13:16	394
09:57	593	10:37	553	11:17	513	11:57	473	12:37	433	13:17	393
09:58	592	10:38	552	11:18	512	11:58	472	12:38	432	13:18	392
09:59	591	10:39	551	11:19	511	11:59	471	12:39	431	13:19	391
10:00	590	10:40	550	11:20	510	12:00	470	12:40	430	13:20	390
10:01	589	10:41	549	11:21	509	12:01	469	12:41	429	13:21	389
10:02	588	10:42	548	11:22	508	12:02	468	12:42	428	13:22	388
10:03	587	10:43	547	11:23	507	12:03	467	12:43	427	13:23	387
10:04	586	10:44	546	11:24	506	12:04	466	12:44	426	13:24	386
10:05	585	10:45	545	11:25	505	12:05	465	12:45	425	13:25	385
10:06	584	10:46	544	11:26	504	12:06	464	12:46	424	13:26	384
10:07	583	10:47	543	11:27	503	12:07	463	12:47	423	13:27	383
10:08	582	10:48	542	11:28	502	12:08	462	12:48	422	13:28	382
10:09	581	10:49	541	11:29	501	12:09	461	12:49	421	13:29	381
10:10	580	10:50	540	11:30	500	12:10	460	12:50	420	13:30	380
10:11	579	10:51	539	11:31	499	12:11	459	12:51	419	13:31	379
10:12	578	10:52	538	11:32	498	12:12	458	12:52	418	13:32	378
10:13	577	10:53	537	11:33	497	12:13	457	12:53	417	13:33	377
10:14	576	10:54	536	11:34	496	12:14	456	12:54	416	13:34	376
10:15	575	10:55	535	11:35	495	12:15	455	12:55	415	13:35	375
10:16	574	10:56	534	11:36	494	12:16	454	12:56	414	13:36	374
10:17	573	10:57	533	11:37	493	12:17	453	12:57	413	13:37	373
10:18	572	10:58	532	11:38	492	12:18	452	12:58	412	13:38	372
10:19	571	10:59	531	11:39	491	12:19	451	12:59	411	13:39	371
10:20	570	11:00	530	11:40	490	12:20	450	13:00	410	13:40	370
10:21	569	11:01	529	11:41	489	12:21	449	13:01	409	13:41	369
10:22	568	11:02	528	11:42	488	12:22	448	13:02	408	13:42	368
10:23	567	11:03	527	11:43	487	12:23	447	13:03	407	13:43	367
10:24	566	11:04	526	11:44	486	12:24	446	13:04	406	13:44	366
10:25	565	11:05	525	11:45	485	12:25	445	13:05	405	13:45	365
10:26	564	11:06	524	11:46	484	12:26	444	13:06	404	13:46	364
10:27	563	11:07	523	11:47	483	12:27	443	13:07	403	13:47	363
10:28	562	11:08	522	11:48	482	12:28	442	13:08	402	13:48	362
10:29	561	11:09	521	11:49	481	12:29	441	13:09	401	13:49	361

2.2 Point Tables

LASER RUN POINT TABLE
Individual Men / Women 60+ / 70 +

time	pts	Time	pts	Time	pts	time	pts	time	pts	time	pts	time	pts
05:00	620	05:40	580	06:20	540	07:00	500	07:40	460	08:20	420	09:00	380
05:01	619	05:41	579	06:21	539	07:01	499	07:41	459	08:21	419	09:01	379
05:02	618	05:42	578	06:22	538	07:02	498	07:42	458	08:22	418	09:02	378
05:03	617	05:43	577	06:23	537	07:03	497	07:43	457	08:23	417	09:03	377
05:04	616	05:44	576	06:24	536	07:04	496	07:44	456	08:24	416	09:04	376
05:05	615	05:45	575	06:25	535	07:05	495	07:45	455	08:25	415	09:05	375
05:06	614	05:46	574	06:26	534	07:06	494	07:46	454	08:26	414	09:06	374
05:07	613	05:47	573	06:27	533	07:07	493	07:47	453	08:27	413	09:07	373
05:08	612	05:48	572	06:28	532	07:08	492	07:48	452	08:28	412	09:08	372
05:09	611	05:49	571	06:29	531	07:09	491	07:49	451	08:29	411	09:09	371
05:10	610	05:50	570	06:30	530	07:10	490	07:50	450	08:30	410	09:10	370
05:11	609	05:51	569	06:31	529	07:11	489	07:51	449	08:31	409	09:11	369
05:12	608	05:52	568	06:32	528	07:12	488	07:52	448	08:32	408	09:12	368
05:13	607	05:53	567	06:33	527	07:13	487	07:53	447	08:33	407	09:13	367
05:14	606	05:54	566	06:34	526	07:14	486	07:54	446	08:34	406	09:14	366
05:15	605	05:55	565	06:35	525	07:15	485	07:55	445	08:35	405	09:15	365
05:16	604	05:56	564	06:36	524	07:16	484	07:56	444	08:36	404	09:16	364
05:17	603	05:57	563	06:37	523	07:17	483	07:57	443	08:37	403	09:17	363
05:18	602	05:58	562	06:38	522	07:18	482	07:58	442	08:38	402	09:18	362
05:19	601	05:59	561	06:39	521	07:19	481	07:59	441	08:39	401	09:19	361
05:20	600	06:00	560	06:40	520	07:20	480	08:00	440	08:40	400	09:20	360
05:21	599	06:01	559	06:41	519	07:21	479	08:01	439	08:41	399	09:21	359
05:22	598	06:02	558	06:42	518	07:22	478	08:02	438	08:42	398	09:22	358
05:23	597	06:03	557	06:43	517	07:23	477	08:03	437	08:43	397	09:23	357
05:24	596	06:04	556	06:44	516	07:24	476	08:04	436	08:44	396	09:24	356
05:25	595	06:05	555	06:45	515	07:25	475	08:05	435	08:45	395	09:25	355
05:26	594	06:06	554	06:46	514	07:26	474	08:06	434	08:46	394	09:26	354
05:27	593	06:07	553	06:47	513	07:27	473	08:07	433	08:47	393	09:27	353
05:28	592	06:08	552	06:48	512	07:28	472	08:08	432	08:48	392	09:28	352
05:29	591	06:09	551	06:49	511	07:29	471	08:09	431	08:49	391	09:29	351
05:30	590	06:10	550	06:50	510	07:30	470	08:10	430	08:50	390	09:30	350
05:31	589	06:11	549	06:51	509	07:31	469	08:11	429	08:51	389	09:31	349
05:32	588	06:12	548	06:52	508	07:32	468	08:12	428	08:52	388	09:32	348
05:33	587	06:13	547	06:53	507	07:33	467	08:13	427	08:53	387	09:33	347
05:34	586	06:14	546	06:54	506	07:34	466	08:14	426	08:54	386	09:34	346
05:35	585	06:15	545	06:55	505	07:35	465	08:15	425	08:55	385	09:35	345
05:36	584	06:16	544	06:56	504	07:36	464	08:16	424	08:56	384	09:36	344
05:37	583	06:17	543	06:57	503	07:37	463	08:17	423	08:57	383	09:37	343
05:38	582	06:18	542	06:58	502	07:38	462	08:18	422	08:58	382	09:38	342
05:39	581	06:19	541	06:59	501	07:39	461	08:19	421	08:59	381	09:39	341

07

EVENT RULES



PART A

THE EVENT

1 GENERAL ASPECTS

- 1.1 Definition
- 1.2 Sphere of application
- 1.3 Categories
- 1.4 Formats
- 1.5 Age Groups and sequence of events
- 1.6 Organisation of events

- 1.7 Teams and Mixed Relay
- 1.8 Clothing
- 1.9 Schedule of events
- 1.10 Participation
- 1.11 Doping Controls
- 1.12 Competition Authorities

2. PENALTIES

3 AWARDS

- 3.1 World Championships Medals
- 3.2 World Championships Titles

- 3.3 World Rankings

APPENDICES

Appendix 1

Transition Area

Appendix 2

Transition Area Boxes

BIATHLE

PART A

THE EVENT

1 GENERAL ASPECTS

1.1 Definition

UIPM Biathle is a UIPM sport combining Running and Swimming. UIPM Biathle competitions are organised nationally and internationally. All competitions can be organised on any surface (grass, sand asphalt etc.).

1.2 Sphere of application

UIPM Biathle is covered by the UIPM Rules, especially the UIPM Competition, Medical and Advertising and Media Rules, as far as not specified differently in the following.

1.3 Categories

1.3.1

There are two UIPM Biathle Categories:

- Category A: UIPM Biathle-Triathlon World Championships, Continental Championships, Multisport Games.
- Category B: Regional Competitions, UIPM Biathle National Tour.

1.3.2

UIPM Biathle Category A competitions are awarded following a bid and selection process by the UIPM Executive Board or Continental Confederations. The organizers need to organize both Biathle and Triathlon events. In UIPM World Championships the competition lane must be enclosed by UIPM branded tape or UIPM branded triangles. Also, electronic timing and finish line monitoring is obligatory in these competitions.

1.3.3

For UIPM Biathle Category A competitions a water quality test must be made 30 days before the competition and the certificate sent to the UIPM Headquarters. The samples must contain a mixture of water collected from three different locations on the swim course. Test results must not exceed the following standards:

Sea and Transition Water

- a) pH between 6 and 9
- b) Enterococci not more than 100 per 100ml (ufc/100ml)
- c) E' coli (fresh water) not more than 250 per 100 ml (ufc/100ml)
- d) The swim part is cancelled in presence of red tide algal Bloom

Inland Water

- a) pH between 6 and 9
- b) Enterococci not more than 200 per 100ml (ufc/100ml)
- c) E' coli (fresh water) not more than 500 per 100 ml (ufc/100ml)
- d) The presence of blue-green algal blooms/scum (cyanobacteria) with more than 100.000 cells/ml

1.3.4

The UIPM representatives going to check the venue for a site visit will forward any doubt about the water quality. They will then advise if more tests should be done.

The water temperature should be a minimum of 18°C and a maximum of 31°C. It should be checked the day of the race, 2 hours before the start, and in the middle of the course at a depth of 40 cm.

1.4 FORMATS

UIPM Biathle in Category A and Category B events is continuous and organised outdoors.

1.5 Age Groups and sequence of events



1.5.1

INDIVIDUAL

Group	Age	Run	Swim	Run	Total Run	Total Swim
Under 9	8 and younger	200	50	200	400	50
Under 11	9-10	400	50	400	800	50
Under 13	11-12	400	50	400	800	50
Under 15	13-14	800	100	800	1600	100
Under 17	15-16	1200	200	1200	2400	200
Under 19	17-18	1600	200	1600	3200	200
Juniors	19-21	1600	200	1600	3200	200
Seniors	22 and over	1600	200	1600	3200	200
Masters 40+	40-49	1200	100	1200	2400	100
Masters 50+	50-59	1200	100	1200	2400	100
Masters 60+	60 and over	800	100	800	1600	100
Masters 70+	70 and over	400	100	400	800	100

MIXED RELAY

Group	Age	Run (per person)	Swim (per person)	Run (per person)	Total Run (per person)	Total Swim (per person)
Under 9	8 and younger	200	50	200	400	50
Under 11	9-10	400	50	400	800	50
Under 13	11-12	400	50	400	800	50
Under 15	13-14	400	50	400	800	50
Under 17	15-16	600	100	600	1200	100
Under 19	17-18	800	100	800	1600	100
Juniors	19-21	800	100	800	1600	100
Seniors	22 and over	800	100	800	1600	100
Masters 40+	40-49	600	100	600	1200	100
Masters 50+	50-59	600	100	600	1200	100
Masters 60+	60 and over	400	50	400	800	50
Masters 70+	70 and over	400	50	400	800	50

1.5.2

In UIPM Biathlon individual events, athletes are allowed to enter in one age group only.

1.5.3

In the event of there being insufficient participants in an age category to justify organisation of a separate race, the organiser may permit athletes to compete in the immediately adjacent upper category (e.g. U11 to U13 etc.) and in the younger categories for Masters. If there are free places in one age group, then two or more age groups can be merged to form one heat, as long as the distances of the age groups are respected.

1.5.4

In the case of relays with team composed by athletes from different age groups, they can compete together in the immediately adjacent upper category (e.g. an U11 with an U13 will compete in the U13 age group.) For Masters, athletes from different age groups can compete together but must register in the younger Masters age group (e.g. a Master 40+ with a Master 50+ will compete in the Master 40+ age group).

1.5.5

In accordance to this principle, athletes classified as "Junior" and competing in a "Senior" category because of insufficient number of athletes of the same age, will be awarded a World Junior Champion title according to their age and despite the time and place of their arrival on the finish line.

-
- 1.5.6** In Beach Biathle, if the running course is very soft sand, the running distances must be reduced by 20%. If only a part of the loop is run on very soft sand, 20% of the total sand surface per loop will be deducted (for example if 200m are run on very soft sand each loop, 40 meters will be deducted to the loop distance).
- 1.5.7** In UIPM Biathle the sequence of events is as follows: Running – Swimming – Running
- 1.5.8** Competitions may be organised separately for men and women, or combined so that they compete against each other, but they will be classified separately.
- 1.5.9** In the UIPM Biathle/Triathle World Championships, one (1) additional division is created besides the Elite Division (for UIPM registered athletes); it's the Open Division (for individual participants or athletes coming from other sports with certain athletic background).

1.6 ORGANISATION OF EVENTS

- 1.6.1** Each of the different events of the competition must be organised in one area, so as to provide a flow from one event to another. Spectators must be able to see as much as possible of the entire competition from their designated area.
- 1.6.2** A technical meeting must take place for each competition day. The TM defines the final start list. Following the Technical Meeting, no changes will be allowed.
- 1.6.3** For safety reasons, a maximum of 24 athletes will be allowed to participate in one heat. If the course is not wide enough for athletes to stand in single line, athletes will be split into two or more semi-finals if needed.
- In the case of semi-finals, National Federations with more than one athlete should have their athletes equally split between the semi-finals.
- The first three (3) athletes per semi-finals will be automatically qualified for the final. Depending on the number of semi-finals, the others finalists will qualify through their time.
- A total of 24 athletes will be allowed in the final after qualifications.
- 3 teams maximum per National Federations are allowed in the Elite Division Mixed Relay competition, but only the best ranked team per nation will be allowed to receive a medal.
- 1.6.4** The transition area will be placed within the final 50 meters of the first running event. (See Appendix 1). Competitors must remove their shoes in this area. The Organiser must place preassigned boxes out of the path of competitors on both sides of the transition area. Each box must be identified with the respective athlete's start number. Boxes will be numbered on both sides so that it can be read from both directions (because athletes will wear the shoes again after the swimming event (See Appendix 2). The swim course starts from a minimum depth of 90 cm. The course before that point counts as the running course.
- 1.6.5** The swimming event may be in a natural or artificial body of water. The swim course should be reasonably protected from potential adverse weather conditions. For sea or lake events, the course must be designed so that safety monitor positions and mobile evacuation units can be stationed and operate from all sides of the course.
- 1.6.6** Advanced notice of the layout of the swim course must be made available to athletes by the Organiser. The swim course may be one directional or an 'out and back'. If out and back, a separation lane will divide swimmers heading out and those coming back.
- 1.6.7** The exit from the water should be made progressive if possible, making the transition to Running smooth and easy. If this is not possible, the step or edge of the pool or other body of water must not exceed 0,30 metres from the water's surface.



-
- 1.6.8** For safety reasons, the area near the water, and especially the diving area, must not be slippery to ensure safe entry and exit of the swimming course. This may require the installation of a slip free surface, i.e. a rubber mat.
- 1.6.9** To ensure the safety of athletes, Organisers must provide medical staff on site. Lifeguards must be present in the swimming area.
- 1.6.10** Due to the probability of close finishes, a camera must be installed at the finish line to record and distinguish the order of the athletes as they cross the finish line. For security and media purposes, the finish line should be square against the line of the course, exiting into a straight funnel.
- 1.6.11** A clock keeping global time of the competition must run for the duration of the race, until the last competitor has crossed the finish line.
- 1.6.12** Timing will be calculated in hundredths of a second For UIPM Biathlon/Triathlon World Championships, electronic timing provided by a Transponder System is compulsory for all races.
- 1.6.13** To break any tie hundredths of a second timing shall prevail.

1.7 TEAMS AND MIXED RELAY

- 1.7.1** Teams comprise 3 athletes and are formed by comprising the highest placed 3 athletes from the same Nation in each category. Their times will be added together to decide the final placings.
- 1.7.2** The Mixed Relay comprises 2 athletes: 1 male and 1 female

1.8 CLOTHING

- 1.8.1** For UIPM Biathlon competitions, athletes should wear a one or two-piece suit. In all cases, the upper body part must be covered. The nationality of the athlete must be identified on the suit (Either name of the country in full or 3-letters country code).
- 1.8.2** Footwear: a) must not be worn in the Swimming but b) must be worn when running.
- 1.8.3** Clear numbers have to be shown on the front and on both shoulders. They should be made visible using waterproof markers or stickers.
- 1.8.4** Athletes participating in UIPM BT competitions and representing the same NF must wear the same style and colours of competitive apparel in order to clearly identify the country which they represent.
- 1.8.5** The UIPM logo patch must be placed on the Biathlon-Triathlon apparel according to 2021 UIPM Uniform Guidelines. Non placing or wrongly placing of the UIPM logo patch will be penalized by deduction of 10 seconds.

1.9 SCHEDULE OF EVENTS

- 1.9.1** The official running courses must be made available to the teams before the competition for athletes to familiarise themselves with their respective course. General Training sessions for running and swimming must be organised in either pool or sea (according to the competition course).
- 1.9.2** The competition begins with a pack start, in which all competitors gather at the starting line. Firing a start gun, a whistle or an air horn starts the race. In case of a false start, the relevant athlete's start number will be called out and that athlete will be penalised by 10 seconds which will be added to the final running time at the end of the race.

1.9.3 Competitors must stay inside the competition lane during the race. Competitors leaving the competition lane will be disqualified. Jockeying for position during the first metres of the race will be accepted but unsportsmanlike conduct will not be tolerated and will result in disqualification.

1.9.4 Runners complete half the total running distance before entering a 50-metre transition area where athletes remove their shoes (and socks if worn) and place them in the pre-assigned boxes with dimensions of approximately 40cm x 30 cm x 20 cm. Athletes are required to place all their kit in the transition boxes and must not hand them to other persons or leave them on the ground or anywhere else.

1.9.5 After running athletes dive into the water and swim the required swimming distance freestyle before exiting the water, putting back on their shoes and running the second leg of the run to the finish line. Athletes must wear their shoes when running. In UIPM Biathle the first person to cross the finish line wins.

1.9.6 Every item carried during any part of the competition (e.g. goggles, cap, water bottle, etc), must be carried throughout or remain in the respective athlete's transition box. Any athlete disposing of or handing over any item will incur a 10 second penalty to be added upon crossing the finish line.

1.10 PARTICIPATION

1.10.1 Registration for Category A Competitions is coordinated through the athlete's National Modern Pentathlon Federation. For UIPM World Championships the National Federation has to register all the delegation (Elite Division athletes, coaches and officials) through the NF Portal. For Open Division, athletes will register through a link accessible on UIPM website homepage.

1.10.2 Organisers must allow time, on the day preceding the event, for accreditation and for the confirmation of registered competitors. No change in registration will be allowed after the Technical Meeting.

1.11 DOPING CONTROLS

1.11.1 Doping Controls are organised in accordance with the UIPM Anti-Doping Rules and Procedures.

1.12 COMPETITION AUTHORITIES

1.12.1 **The Jury of Appeal** is composed of the Chairperson nominated by the UIPM Executive Board, one member nominated by the LOC and three further members elected from amongst the Team Representatives.

2 PENALTIES

2.1 An athlete will be penalised by a time penalty of a 10 seconds penalties for each of the following offences:

- i) starting the race before the official start given by the judge (false start);
- ii) not disposing items into the respective transition box or handing items over to someone;
- iii) contravening clothing regulations (including also what mentioned in 1.9.5);

2.2 An athlete is eliminated for:

- i) not completing the course (either total running or swimming distance);
- ii) using devices that may aid his speed, buoyancy or endurance in swimming;
- iii) not swimming bare foot or using any other items except swimming caps and swimming goggles;

2.3 An athlete is disqualified for:

- i) leaving the competition lane (course deviation);
- ii) unsportsmanlike conduct;
- iii) wilfully, with intent, pushing, swimming across or obstructing another athlete;
- iv) jostling, running across or obstructing another athlete;



3 AWARDS

3.1 WORLD CHAMPIONSHIPS MEDALS

- 3.1.1 Gold, Silver and Bronze medals will be given in each category and team event competition.
- 3.1.2 The UIPM and the Organiser will share the expenses to produce the medals after the approval of the design and the cost by UIPM.

3.2 WORLD CHAMPIONSHIPS TITLES

- 3.2.1 Gold medallists in all age groups of the BTWCH and for both genders will receive the title "UIPM Biathlon World Champion" irrespective of having registered via NF portal or via web link.

3.3 WORLD RANKINGS

- 3.3.1 The UIPM Biathlon World Ranking follows the UIPM Modern Pentathlon World Ranking. Athletes participate in different competitions (UIPM Biathlon and Triathlon World Championships, Continental Championships and National and Regional Competitions) will be awarded relevant points according to the result and the competition level as demonstrated in the following world ranking points chart (see next page).

- 3.3.2

Category A Competitions		Category B Competitions	
Place	Points	Place	Points
1	35	1	25
2	30	2	22
3	27	3	20
4	24	4	18
5	22	5	16
6	20	6	15
7	19	7	14
8	18	8	13
9	17	9	12
10	16	10	11
11	15	11	10
12	14	12	9
13	13	13	8
14	12	14	7
15	11	15	6
16	10	16	5
17 / 18 / 19 / 20 / ...	1	17 / 18 / 19 / 20 / ...	1

Offences	Rule	Penalty	Paid at
False start	2.1.i	10"	End of the race
Not disposing items in the transition boxes	2.1.ii	10"	End of the race
Contravening clothing regulations	2.1.iii	10"	Start / End of the race
Not completing the course	2.2.i	Elimination	
Use of non-authorized devices in swimming	2.2.ii / iii	Elimination	
Leaving the competition lane	2.3.i	Disqualification	
Unsportsmanlike conduct	2.3.ii	Disqualification	
Obstruction in swimming	2.3.iii	Disqualification	
Obstruction in running	2.3.iv	Disqualification	

APPENDIX 1

Example of Transition Area

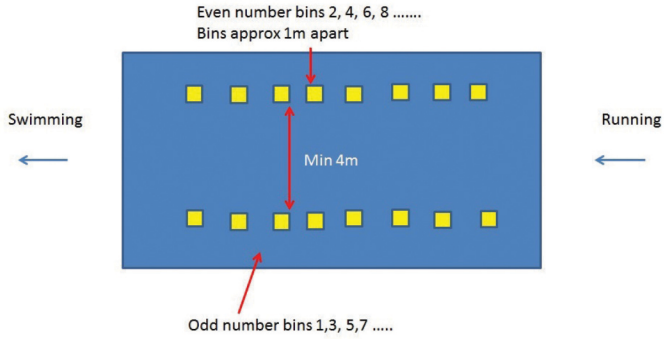

APPENDIX 2

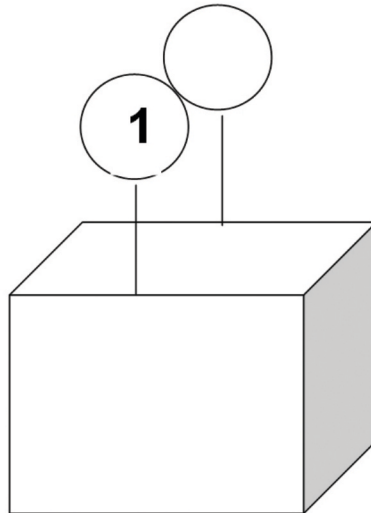

dimensions of approximately 40cm x 30 cm x 20cm



TRIATHLE

PART A

THE EVENT

1. GENERAL ASPECTS

- 1.1 Definition
- 1.2 Sphere of application
- 1.3 Categories
- 1.4 Formats
- 1.5 Age Groups and sequence of events
- 1.6 Organisation of events
- 1.7 Shooting equipment

- 1.8 Teams and Mixed Relay
- 1.9 Clothing
- 1.10 Schedule of events
- 1.11 Participation
- 1.12 Doping Controls
- 1.13 Competition Authorities

2. PENALTIES

3. AWARDS

- 3.1 World Championships Medals
- 3.2 World Championships Titles

- 3.3 World Rankings

APPENDICES

- Appendix 1 Shooting Station example
- Appendix 2 Transition Area
- Appendix 3 Transition Boxes

TRIATHLE

PART A

THE EVENT

1 GENERAL ASPECTS

1.1 Definition

UIPM Triathlon is a UIPM sport combining the disciplines of Shooting, Swimming and Running. Triathlon competitions are organised nationally and internationally. All competitions can be organised on any surface (grass, sand asphalt etc.).

1.2 Sphere of application

UIPM Triathlon is covered by the UIPM Rules, especially the UIPM Modern Pentathlon Combined Event rules and the Modern Pentathlon Swimming Event rules, Medical/Anti-Doping and Advertising and Media Rules insofar as not specified differently in the following.

1.3 Categories

1.3.1

There are two UIPM Triathlon Categories:

- Category A: UIPM Biathlon-Triathlon World Championships, Continental Championships, Multisport Games.
- Category B: Regional Competitions, UIPM Triathlon National Tour.

1.3.2

For UIPM Triathlon Category A competitions are awarded following a bid and selection process by the UIPM Executive Board or Continental Confederations. In UIPM World Championships the competition lane must be enclosed by UIPM branded tape or UIPM branded triangles. Electronic timing and finish line monitoring is obligatory in these competitions.

1.3.3

For UIPM Triathlon Category A competitions a water quality test must be made 30 days before the competition and the certificate sent to the UIPM Headquarters. The samples must contain a mixture of water collected from three different locations on the swim course. Test results must not exceed the following standards:

Sea and Transition Water

- a) pH between 6 and 9
- b) Enterococci not more than 100 per 100ml (ufc/100ml)
- c) E' coli (fresh water) not more than 250 per 100 ml (ufc/100ml)
- d) The swim part is cancelled in presence of red tide algal Bloom

Inland Water

- a) pH between 6 and 9
- b) Enterococci not more than 200 per 100ml (ufc/100ml)
- c) E' coli (fresh water) not more than 500 per 100 ml (ufc/100ml)
- d) The presence of blue-green algal blooms/scum (cyanobacteria) with more than 100.000 cells/ml

1.3.4

The UIPM representatives going to check the venue for a site visit will forward any doubt about the water quality. They will then advise if more tests should be done.

The water temperature should be a minimum of 18°C and a maximum of 31°C. It should be checked at the day of the race, 2 hours before the start, and in the middle of the course at a depth of 40 cm.

1.4 FORMATS

1.5 Age Groups and sequence of events

UIPM Biathlon in Category A and Category B events is continuous and organised outdoors.



132

Age groups and sequence of events for UIPM Triathlon are as follows:

U19, Junior & Senior athletes will start to run 1 lap without shooting & swimming and then will have 4 laps of normal Triathlon (running / shooting / swimming).

U13, U15, M40 & M50 will start to run and shoot 1 lap without swimming and then will have 2 laps of normal Triathlon (running / shooting / swimming).

INDIVIDUAL

Group	Age	Sequence	Total Swim	Total Run	Total Hits	Shooting Distance
Under 11	10 and younger	2x300 run + 2x25 swim + 2x5 hits	50	600	10	5m (both hands)
Under 13	11-12	3x300 run + 2x50 swim + 3x5 hits	100	900	15	5m
Under 15	13-14	3x600 run + 2x50 swim + 3x5 hits	100	1800	15	5m
Under 17	15-16	4x600 run + 4x50 swim + 4x5 hits	200	2400	20	10m
Under 19	17-18	5x600 run + 4x50 swim + 4x5 hits	200	3000	20	10m
Juniors	19-21	5x600 run + 4x50 swim + 4x5 hits	200	3000	20	10m
Seniors	22 and over	5x600 run + 4x50 swim + 4x5 hits	200	3000	20	10m
Masters 40+	40-49	3x600 run + 2x50 swim + 3x5 hits	100	1800	15	10m
Masters 50+	50-59	3x600 run + 2x50 swim + 3x5 hits	100	1800	15	10m
Masters 60+	60 and over	2x600 run + 2x50 swim + 2x5 hits	100	1200	10	5m

Age groups and sequence of events for UIPM Triathlon Mixed Relay are as follows:

Each U19, Junior & Senior athletes of the Relay will start to run 1 lap without shooting & swimming and then will have 2 laps of normal Triathlon (running / shooting / swimming).

MIXED RELAY

Group	Age	Sequence (per person)	Swim (per person)	Run (per person)	Hits (per person)	Shooting Distance
Under 11	10 and younger	2x300 run + 2x25 swim + 2x5 hits	50	600	10	5m (both hands)
Under 13	11-12	2x300 run + 2x50 swim + 2x5 hits	100	600	10	5m
Under 15	13-14	2x600 run + 2x50 swim + 2x5 hits	100	1200	10	5m
Under 17	15-16	2x600 run + 2x50 swim + 2x5 hits	100	1200	10	10m
Under 19	17-18	3x600 run + 2x50 swim + 2x5 hits	100	1800	10	10m
Juniors	19-21	3x600 run + 2x50 swim + 2x5 hits	100	1800	10	10m
Seniors	22 and over	3x600 run + 2x50 swim + 2x5 hits	100	1800	10	10m
Masters 40+	40-49	2x600 run + 2x50 swim + 2x5 hits	100	1200	10	10m
Masters 50+	50-59	2x600 run + 2x50 swim + 2x5 hits	100	1200	10	10m
Masters 60+	60 and over	2x600 run + 2x50 swim + 2x5 hits	100	800	10	5m

13.2 In UIPM Triathlon individual events, athletes are allowed to enter in one age group only.

13.3 In the event of there being insufficient participants in an age category to justify organisation of a separate race, the organiser may permit athletes to compete in the immediately adjacent upper category (e.g. U11 to U13 etc.) and in the younger categories for Masters. If there are free places in one age group, then two or more age groups can be merged to form one heat, as long as the distances of the age groups are respected.

13.4 In the case of relays with team composed by athletes from different age groups, they can compete together in the immediately adjacent upper category (e.g. an U11 with an U13 will compete in the U13 age group.) For Masters, athletes from different age groups can compete together but must register in the younger Masters age group (e.g. a Master 40+ with a Master 50+ will compete in the Master 40+ age group).

13.5 In accordance to this principle, athletes classified as "Junior" and competing in a "Senior" category because of insufficient number of athletes of the same age, will be awarded a World Junior Champion title according to their age and despite the time and place of their arrival on the finish line.

-
- 1.5.6** In Beach Triathlon, if the running course is very soft sand, the running distances must be reduced by 20%. If only a part of the loop is run on very soft sand, 20% of the total sand surface per loop will be deducted (for example if 200m are run on very soft sand each loop, 40 meters will be deducted to the loop distance).
- 1.5.7** Individual events can be organised separately for men and women, or combined so that they compete against each other.
If there are free places in one age group, then two or more age groups can be merged to form one heat, as long as the distances of the age groups are respected.
- 1.5.8** In the UIPM Biathlon/Triathlon World Championships, one (1) additional division is created besides the Elite Division (for UIPM registered athletes); the Open Division (for individual participants or athletes coming from other sports with certain athletic background).

1.6 ORGANISATION OF EVENTS

- 1.6.1** Each of the different events of the competition must be organised in one area, so as to provide a flow from one event to another. Spectators must be able to see as much as possible of the entire competition from their designated area.
- 1.6.2** A technical meeting must take place for each competition day. The TM defines the final start order. Following the Technical Meeting, no changes will be allowed.
- 1.6.3** The current UIPM Triathlon Rules apply to the provision of equipment and its use during the course of the competition. Additionally, for the Shooting leg(s) only, the competition organiser must provide shooting targets according to Rule 1.7 below, respecting the information given in Appendix 1, stating in the invitation letter the type and number of targets that will be available for the competition.
- 1.6.4** In case for safety reasons, a maximum of 24 athletes will be allowed to participate in one heat and in all cases if the course is not wide enough for athletes to stand in single line, athletes will be split into two or more semi-finals if needed. In the case of semi-finals, National Federations with more than one athlete should have their athletes equally split between the semi-finals.
- The first three (3) athletes per semi-finals will be automatically qualified for the final. Depending on the number of semi-finals, the others qualified athletes will be qualified through their time.
- 24 athletes will be allowed in the final after qualifications.
- 3 teams maximum per National Federations are allowed in the Elite Division Mixed Relay competition, but only the best ranked team will be allowed to receive a medal.
- 1.6.5** In addition to any other UIPM Biathlon rule applicable to UIPM Triathlon, in the specific case of an event run on sand (Beach Triathlon), the course has to be cleaned and set up appropriately by the event organiser so that will not create any danger for the athletes (from stones etc). The sand has to be flattened at the end of every third competition with appropriate equipment.



1.7 SHOOTING EQUIPMENT

1.7.1

In Triathlon, the Organizing committees are allowed to use these types of targets:

- Hit Targets
- Hit & Miss Targets
- Hybrid Targets
- Precision Targets

The mentioned equipment must be homologated by UIPM. If you have any doubt, please contact UIPM at development@pentathlon.org

Athletes are allowed to use these types of pistols:

- Full Laser Pistols
- Laser Containers

The mentioned equipment must be homologated by UIPM. If you have any doubt, please contact UIPM at development@pentathlon.org

1.8 TEAMS AND MIXED RELAY

1.8.1

Teams comprise 3 athletes and are formed by comprising the highest placed 3 athletes from the same Nation in each category. Their times will be added together to decide the final placings.

1.8.2

The Mixed Relay comprises 2 athletes: 1 male and 1 female.

1.9 CLOTHING

1.9.1

The clothing rules for UIPM Biathlon apply to Triathlon in all its forms. Footwear must be worn for Running, if not on soft sand surface. Competition invitations must state the surface type.

1.9.2

Clear numbers have to be shown on the front and on both shoulders. They should be made visible using waterproof markers or stickers.

1.9.3

Athletes participating in UIPM BT competitions and representing the same NF must wear the same style and colours of competitive apparel in order to clearly identify the country which they represent.

1.9.4

The UIPM logo patch must be placed on the Biathlon-Triathlon apparel according to 2021 UIPM Uniform Guidelines. Non placing or wrongly placing of the UIPM logo patch will be penalized by deduction of 10 seconds.

1.10 SCHEDULE OF EVENTS

1.10.1

The official running courses must be made available to the teams before the competition for athletes to familiarise themselves with their respective course. General Training sessions for running and swimming must be organised in either pool or sea (according to the competition course).

1.10.2

For shooting, open training sessions must be organised before the competition. A separate shooting warm up area must be provided for athletes for 15 minutes warm up before the competition. At latest 5 minutes before the start, athletes should have set up their shooting position on the competition range.

1.10.3

The competition begins with a pack start, in which all competitors gather at the starting line. Firing a start gun, a whistle or an air horn starts the race. In case of a false start, the relevant athlete's start number will be called out and that athlete will be penalised by 10 seconds. Such 10 second penalty on a pentathlete is imposed at their shooting station; before applying any penalty, the range officers need to have approval from TD. If the penalty cannot be imposed at the shooting station, it will be added to the final running time at the end of the race.

1.10.4

Competitors must stay inside the competition lane during the race. Competitors leaving the competition lane will be disqualified.

1.10.5

Athletes start in a line up to 25 m from the shooting position. In Street Triathlon they must previously have placed their shoes in boxes with dimensions of approximately 40cm x 30 cm x 20 cm in the Transition Area. If the shooting position is also on a hard surface, athletes start the competition with shoes: The Transition Area must be placed before the swimming segment.

-
- 1.10.6** Transitioning back on to the running leg, athletes are not allowed to throw any personal items (including goggles, water bottles and cap) away and are not allowed to hand them over to anyone. Any violation will be punished with a 10 second penalty.
- 1.10.7** At the shooting range, athletes must complete successfully 5 hits before continuing to the next segment (the swimming). If after 50 seconds the athlete has not completed 5 hits, the athlete may continue to the swimming.
- 1.10.8** Athletes are not allowed to stop shooting until the end of their 50 seconds or before reaching the 5 hits: otherwise they will incur a 10 second' penalty to be given at the shooting range before proceeding to the next leg.
- 1.10.9** The swim course starts from a minimum depth of 90cm. The course before that point counts as the running course. Athletes then dive into the water and swim free style (in any fashion) for the required swimming distance before exiting the water, putting back their shoes (if necessary) to start the running segment.
- 1.10.10** After finishing the running leg, athletes return to their dedicated shooting position for the next shooting series. After the last lap they will cross the finish line in Individual events or changeover zone in Relay. The last team member in the Relay crosses the finish line.
- 1.10.11** Due to the probability of close finishes, a camera must be installed at the finish line to record and distinguish the order of the athletes as they cross the finish line. For security and media purposes, the finish line should be square against the line of the course, exiting into a straight funnel.
- 1.10.12** A clock keeping global time of the competition must run for the duration of the race, until the last competitor has crossed the finish line.
- 1.10.13** Timing will be calculated in hundredths of a second for UIPM Biathlon/Triathlon World Championships, electronic timing provided by a Transponder System is compulsory for the Elite Division races.
- 1.10.14** To break any tie hundredths of a second timing shall prevail.

1.11 PARTICIPATION

- 1.11.1** The current Biathlon Rules apply to UIPM Triathlon.

1.12 DOPING CONTROLS

- 1.12.1** The current Biathlon Rules apply to UIPM Triathlon.

1.13 COMPETITION AUTHORITIES

- 1.13.1** **The Jury of Appeal** comprises the Chairperson nominated by the UIPM Executive Board, one member nominated by the LOC and three further members elected from the Team Representatives.

2. PENALTIES

- 2.1** An athlete will be penalised by a time penalty of a 10 seconds penalties for each of the following offences:
- i) starting the race before the official start given by the judge (false start);
 - ii) not disposing items into the respective transition box or handing items over to someone;
 - iii) contravening clothing regulations;
 - iv) not placing the pistol safely on the table after warm-up or shooting series; *



- v) not touching the shooting table between each shot*, before applying such penalty, a warning must be issued. The respective judge and range officer need to have approval from the TD in the range before applying such penalty.

* These penalties are paid at the shooting range, with the exception of the final shooting series where they are paid in the Last Penalty Stop Area.

2.2

An athlete is eliminated for:

- i) not completing the course (either total running or swimming distance);
- ii) using devices that may aid his speed, buoyancy or endurance in swimming;
- iii) not swimming bare foot or using any other items except swimming caps and swimming goggles;
- iv) starting to run before the shooting time has expired without having successfully completed 5 green lights (4 green lights only);
- v) using a non-approved pistol (In case of pistol tests, athlete must use a pistol which was approved by the testing team);
- vi) shooting on the wrong target;
- vii) using a constant beam during the competition series;
- viii) using audio communication outside of the preparation or warm up time.

2.3

An athlete is disqualified for:

- i) leaving the competition lane (course deviation);
- ii) unsportsmanlike conduct;
- iii) wilfully, with intent, pushing, swimming across or obstructing another athlete;
- iv) jostling, running across or obstructing another athlete;
- v) starting to run before the shooting time has expired without having successfully; completed 5 green lights (3 green lights or less only);
- vi) Athlete exchanging his/her pistol for a non-approved pistol.

Offences	Rule	Penalty	Paid at
False start	2.1.i	10*	LPA or shooting range
Not disposing items in the transition boxes	2.1.ii	10*	LPA or shooting range
Contravening clothing regulations	2.1.iii	10*	LPA or shooting range
Not placing the pistol safely	2.1.iv	10*	LPA or shooting range
Not touching the shooting table	2.1.v	10*	LPA or shooting range
Not completing the course	2.2.i	Elimination	
Use of non-authorized devices in swimming	2.2.ii/iii	Elimination	
Starting before the 50 seconds (4 green lights)	2.2.iv	Elimination	
Use a non-approved pistol	2.2.v	Elimination	
Shooting on the wrong target	2.2.vi	Elimination	
Use of a constant beam during competition	2.2.vii	Elimination	
Use audio communication during competition	2.2.viii	Elimination	
Leaving the competition lane	2.3.i	Disqualification	
Unsportsmanlike conduct	2.3.ii	Disqualification	
Obstruction in swimming	2.3.iii	Disqualification	
Obstruction in running	2.3.iv	Disqualification	
Starting before the 50 seconds (3 green lights or less)	2.3.v	Disqualification	
Exchanging pistol for a non-approved pistol	2.3.vi	Disqualification	

3. AWARDS

3.1 World Championships Medals

3.1.1 Gold, Silver and Bronze medals will be given in each category and event competition.

3.1.2 The UIPM and the Organiser will share the expenses for the production of the medals after the approval of the design and the cost by UIPM.

3.2 WORLD CHAMPIONSHIPS TITLES

3.2.1 Gold medallists in all age groups of the BTWCH and for both genders will receive the title "UIPM Triathlon World Champion" irrespective of having registered via NF portal or via web link.

3.3 WORLD RANKINGS

3.3.1 The UIPM Triathlon World Ranking will work like the UIPM Modern Pentathlon World Ranking: Athletes who participate in different competitions (UIPM Biathlon and Triathlon World Championships, Continental Championships and National and Regional Competitions) will be awarded relevant points according to the result and the competition level as demonstrated in the following world ranking points chart (see next page).

3.3.2

Category A Competitions		Category B Competitions	
Place	Points	Place	Points
1	35	1	25
2	30	2	22
3	27	3	20
4	24	4	18
5	22	5	16
6	20	6	15
7	19	7	14
8	18	8	13
9	17	9	12
10	16	10	11
11	15	11	10
12	14	12	9
13	13	13	8
14	12	14	7
15	11	15	6
16	10	16	5
17 / 18 / 19 / 20 / ...	1	17 / 18 / 19 / 20 / ...	1



**APPENDIX 1
SHOOTING STATION
EXAMPLE**

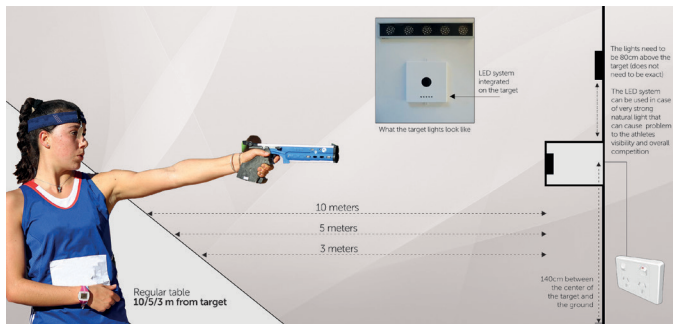

APPENDIX 2

Example of Transition Area

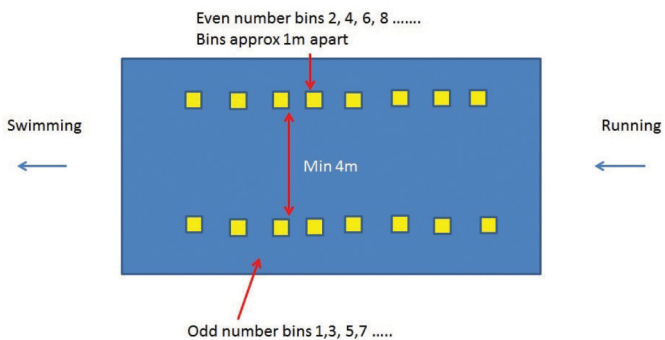

APPENDIX 3

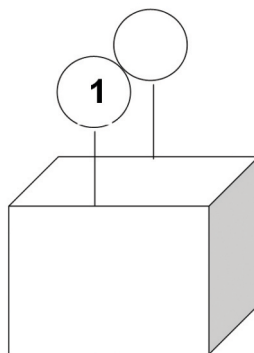

dimensions of approximately 40cm x 30 cm x 20cm

01

GENERAL ASPECTS

This document is in addition to UIPM Modern Pentathlon 2022 Competition Rules. Separate Technical Equipment Regulations are more practical and can respond to necessary innovation or safety updates regarding equipment.

02

EQUIPMENT REGULATIONS



RIDING

PART A

2.7 CLOTHING

- 1 Dress of Pentathletes, coaches and officials

2.8 EQUIPMENT

- | | |
|---------------------------------------|--------------------------------------|
| 1 Headgear | 5 Spurs |
| 2 Whip | 6 Control of Whip and Spurs |
| 3 Use of the Whip | 7 Use of Unauthorized Whip and Spurs |
| 4 Incorrect Use of the Whip and Spurs | |

PART B

2.9 OTHER EQUIPMENT

- | | |
|-------------|---------|
| 1 Obstacles | 2 Flags |
|-------------|---------|

2.10 LOC CONTROL DEVICES AND TOOLS

- | | |
|-----------------|-----------|
| 1 Material Bell | 3 Balance |
|-----------------|-----------|

RIDING

PART A

INDIVIDUAL EQUIPMENT

2.7 CLOTHING

2.7.1 Dress of Pentathletes, Coaches and Officials

Pentathletes, coaches and officials must be properly dressed in the arena. This obligation includes walking the course, but on a non-competition day athletes and coaches are allowed to walk the course dressed in casual clothing (t-shirt and long trousers).

- i) At Olympic Games, World Championships, World Cups and World Cup Finals and Continental Championships all pentathletes must wear a riding jacket or an armed service or police riding uniform with a national insignia (NOC emblem, flag, armband or badge) of a size between 7 and 10cm high. The UIPM logo patch must be placed on the riding jacket according to the current version of the UIPM Uniform Guideline. Missing or wrongly placing of the UIPM logo patch will be penalised by deduction of 10 points, Art. 2.6.3.
- ii) At all other UIPM competitions civilian pentathletes may wear:
 - a) the uniform of a Riding Club recognized by their NF, or
 - b) the hunting uniform (red or black coat, white breeches and hunting cap), or
 - c) Riding Jacket or National Training Suit Jacket, white shirt, collar and tie, breeches, jodhpurs or riding trousers.
- iii) Members of the armed service, police and employees of a military establishment and of a national stud farm may wear civil or service dress. Both must include a shirt, a collar and a tie. NFs must be informed of any restrictions either through the letter of invitation or by UIPM.
- iv) Wearing a back protector (safety vest) for pentathletes is strongly recommended.
- v) The pentathlete is required to use riding boots or chaps with riding shoes. Boots may be made of leather or rubber.
- vi) No jewellery or any visible body piercing is permitted. Athletes must remove or cover these items in a safe way
- vii) Hair must be secured in a way so as not to cover start number.

2.8 EQUIPMENT

2.8.1 Headgear

- i) All pentathletes must wear protective headgear with chinstrap firmly fastened at all times while mounted - including during the warm up. Should the pentathlete lose their headgear during the course, he must stop and replace his headgear before resuming the event.
- ii) **Riding hat standards.** All riding hats, must conform to current FEI International Standards and bear a homologation mark

2.8.2 Whip

The maximum length of the whip is 75cm. The whip may not be weighted at the end nor may it have sharp or cutting edges.

2.8.3 Use of the Whip

The whip may only be used for safety, correction and encouragement. All pentathletes are advised to consider the following good ways of using the whip, which are not exhaustive:

- i) Using the whip in the backhand position for a reminder.
- ii) Having used the whip, giving the horse a chance to respond before using it again.

2.8.4 Incorrect Use of the Whip and Spurs

The Referee (in the competition arena) and the Warm-up Riding Judge (in the warm-up arena) are responsible to evaluate the use of the whip and spurs. These situations are considered as improper riding, and penalised by 10 Modern Pentathlon points, without previous warning. In case of recurrences of these offences, Disqualification will



be applied. In the case of obvious cruelty or clear disrespect of the procedures described, the athlete will be disqualified without previous warning. If a horse's skin is broken, this is automatically considered an excessive use of the whip or spurs.

- i) Hitting horses:
 - a) more than three times in a row (i.e. three times per incident);
 - b) to the extent of causing injury;
 - c) with the whip arm above shoulder height;
 - d) with excessive force;
 - e) without giving the horse time to respond.
- ii) Hitting horses in any place except:
 - a) on the quarters with the whip in either the backhand or forehand position;
 - b) down the shoulder with the whip in the backhand position;
- iii) Hitting horses with excessive frequency:

When examining cases of Excessive Frequency, the Riding Director will consider all the relevant factors such as:

 - a) a rider should never hit a horse more than three times in a row;
 - b) whether the number of hits was reasonable and necessary, taking into account the horse's experience;
 - c) whether the horse was continuing to respond;
 - d) the degree of force that was used; the more times a horse has been hit the stricter will be the view taken over the degree of force which is reasonable.
- iv) Using spurs excessively or persistently

When examining these cases, the Riding Director will consider the same relevant factors listed on number iii) above (hitting horses with excessive frequency).

2.8.5 Spurs

- i) The maximum length of the shank of a spur is 30 mm measured from the outside of the curved part. No spurs with rowels, movable wheels, sharp or cutting edges are allowed.
- ii) When the pentathlete is on horseback the spurs shall always point downwards.

2.8.6

Control of Whip and Spurs

Whip and spurs must be controlled by the Judge for Equipment before mounting and immediately before each mounted pentathlete enters the competition arena.

2.8.7

Use of Unauthorised Whip and Spurs

Using an unauthorised whip or spurs after the control in the arena, warm-up arena or elsewhere in the proximity to the show ground will incur elimination. A pentathlete riding with a whip and/or spurs on a horse not approved for these aids (as distributed in the Technical Meeting is eliminated).

PART B

EQUIPMENT AND FACILITIES PROVIDED BY THE LOC

2.9

OTHER EQUIPMENT

2.9.1 Obstacles

- i) There may be no completely closed obstacles. An obstacle is considered completely closed when a pentathlete jumping its first part cannot leave it without doing a second jump.
- ii) The maximum size of obstacles is:

	Seniors	Juniors
upright obstacle	110cm	100cm
spread obstacle	110 x 130cm	100 x 120cm
oxer (equal bars)	110 x 120cm	100 x 110cm

*The minimum height of Obstacles in Senior competition is 100cm and 85cm in Junior

- iii) The obstacles must be numbered consecutively in the order in which they are to be jumped. Combination obstacles carry only a single number. This number may be repeated at each element for the benefit of the Referee and pentathletes. In this case distinguishing letters will be added (example 8A, 8B).
- iv) Obstacles for the Relay competition are to be chosen from those used in the Individuals competition, but they can be placed in different position in the arena.
- v) The obstacles must be inviting in their overall shape and appearance, varied and match their surroundings. The obstacles and their constituent parts must be such that they can be knocked down while not being so light that they fall at the slightest touch or so heavy that they may cause horses to fall.
- vi) The obstacles must not be un-sporting and they must not cause an unpleasant surprise to foreign pentathletes.

- vii) Poles and other elements of the obstacles are held up by supports (cups). The diameter of the supports must be slightly greater than that of the pole and maximum a third of the circumference, without gripping it. The pole must be able to roll on its support. For planks, balustrades, barriers, gates etc., the diameter of the supports must be more open or even flat.
- viii) FEI approved safety cups must be used as support for the back poles of spread obstacles and in case of a triple-bar to support the centre and back poles of the obstacle. Safety cups must also be used in the exercise area. It is the responsibility of the TD/NTO to establish through the LOC before the event commences whether safety cups are used.
- ix) The limits on the height and spread of obstacles laid down by these rules must be observed with the greatest care. However, if it should happen that a maximum dimension has been marginally exceeded as a result of the material used for construction and/or by the position of the obstacle on the ground, the maximum dimensions laid down will not be considered as having been exceeded, but the permitted tolerance is maximum 5cm.
- x) An obstacle, whatever its construction, can only be called upright when all the elements it is composed of are positioned in the same vertical plane on the take-off side without any rail, bank or ditch in front of it. A wall with an inclined face may not be called an upright obstacle.
- xi) A spread obstacle is an obstacle, which is built in such a manner that it requires an effort both in spread and in height.
- xii) The oxer is a spread obstacle built in such a manner that the top poles on both the take-off and landing sides are the same height and they are parallel.
- xiii) A double or triple combination is understood to be a collection of 2 or 3 elements with distances between them of minimum 7m and maximum 12m that require 2 or 3 successive jumps. The distance is measured from the base of the element on the landing side to the base of the next element on the take-off side.
- xiv) Banks, mounds, ramps and sunken roads, irrespective of whether they include any sort of obstacle and whatever direction in which they should be taken, they are to be regarded as combination obstacles. The UIPM TD/NTO must decide before the competition whether an obstacle of this type is to be considered as a multiple obstacle, and his decision must be shown on the plan of the course.

2.9.2 Flags

Entirely red flags (both sides) and entirely white flags (both sides) must be used to mark the following details of the course:

- i) the start;
- ii) the side limits of the obstacles;
- iii) compulsory turning points;
- iv) the finish;
- v) the obstacles in the warm-up arena.

2.10 LOC CONTROL DEVICES AND TOOLS

2.10.1 Material

The LOC must have disposal of all the material needed to build and rebuild the course and the warm-up obstacles. This includes measure tapes, measure ruler, measure wheel, nails, hammers, tools to repair the ground, hand red flags, the signs "Arena Open" and "Arena Closed", an official clock in the mounting area/warm-up arena, barriers to isolate the unauthorised area, reserves poles and barriers, and so on. LOC must provide manual stop-watches, draw list, horses list, pens and specific paper to register the results, the results after preceding competitions, material for the draw. The Rule book must also be in the Tower.

2.10.2 Bell

2.10.3 Balance

For the conduct of the event the LOC must also equip the Judge Tower with a loud bell, preferably electric.

The LOC must have a ruler or other device to check the length of the whip and a device to check the length of the shank of the spurs.



FENCING

PART A

INDIVIDUAL EQUIPMENT

3.7 CLOTHING

- | | | | |
|---|-----------------|---|--------------------|
| 1 | General aspects | 3 | Breeches and Socks |
| 2 | The Jacket | 4 | The Glove |

3.8 THE EQUIPMENT

- | | | | |
|---|----------|---|--------------|
| 1 | The Mask | 3 | The Bodywire |
| 2 | The Epée | | |

PART B

EQUIPMENT PROVIDED BY THE LOC

3.9 FOP AND PISTE

- | | | | |
|---|---------|---|-----------|
| 1 | The FOP | 2 | The Piste |
|---|---------|---|-----------|

3.10 OTHER EQUIPMENT

- | | | | |
|---|-------------------|---|--------|
| 1 | Scoring Apparatus | 2 | Spools |
|---|-------------------|---|--------|

3.11 THE LOC CONTROL DEVICES AND TOOLS

- | | | | |
|---|--|---|---------------------------|
| 1 | Gauges for Physical Dimensions of Weapons | 5 | Devices for Point Travels |
| 2 | Devices for Flexibility of Blades and Resistance of the Mesh | 6 | Labels |
| 3 | Electrical Checking Device | 7 | Special Ink or Paint |
| 4 | Weights | 8 | Other Equipment and Tools |
| | | 9 | Bonus Round |

PART B

EQUIPMENT PROVIDED BY THE LOC

- Figure 1
- Figure 2
- Figure 4
- Figure 5
- Figure 6
- Figure 7
- Figure 8
- Figure 9

- Design of Fencing Piste Standard Piste
- Epée Dimensions and Flexibility
- Epée: design of point d'arrêt and tip of Point
- Shape of a Non-orthopedic Grip
- Gauge for Checking Weapons
- Weight to Check Pressure
- Checking Point travel

FENCING

PART A

INDIVIDUAL EQUIPMENT

3.7 CLOTHING

3.7.1

General Aspects

- i) The clothing must provide the competitor with the maximum protection compatible with the freedom of movement necessary for fencing. Clothing must be made of sufficiently robust material and be clean and in good condition.
- ii) The material from which the equipment is made must not have a surface that is smooth enough to cause the point d'arrêt, the button or the opponent's hit to glance off it.
- iii) Clothing must be made entirely of material able to resist a pressure of 800 Newtons. Very particular attention must be paid to ventilation access under the armpits, if any is made.
- iv) An undergarment consisting of protective under-plastron covering the vital upper areas of the body resistant to 800 Newtons is also obligatory.
- v) Clothing may be of different colours, but on the body must be a single colour, white or a light shade.
- vi) A homologation mark must appear on blades, under plastron, jackets, breeches, masks, and include the identification of the manufacturer, the date of manufacturing and the FIE or UIPM logo.
- vii) The most recent version of list with homologated equipment is valid.
- viii) No jewellery or any visible body piercing is permitted. Athletes must remove or cover these items in a safe way
- ix) Hair must be secured in a way so as not to cover the name printed on the Fencing jacket or start number.

3.7.2

The Jacket

- i) The lower edge of jacket must overlap the breeches by at least 10cm when the pentathlete is in the on-guard position. The jacket must include a lining making a double thickness of material for the sleeve down to the elbow of the sword arm and covering the flank up to the region of the armpit.
- ii) The equipment of female pentathletes must include breast protectors made of a rigid material or metal.
- iii) Pentathletes must wear their surname and National code letters (Latin characters) on the back of their fencing jacket in clearly legible text either black or dark blue capital letters. The letters must be printed or embroidered and must be between 7 - 12cm high. Failure to do so will incur a penalty according to Rule 3.6.3 v).
- iv) The pentathletes must wear on the non-sword arm, between the elbow and the shoulder, a 7-10 cm armband in the national colours or strip in national colours on their sleeve. Failure to do so will incur a penalty according to Rule 3.6.3 v).
- v) The UIPM logo patch must be placed on the fencing jacket according to the current version of the UIPM Uniform Guideline. Missing or wrongly placing of the UIPM logo patch will be penalised by deduction of 10 points, see Rule 3.6.3 v).

3.1.3

Breeches and Socks

- i) Breeches must be fastened below the knees. With breeches, the pentathlete must wear socks that cover the legs right up to breeches. These socks must be held up in such a way that they cannot fall down.
- ii) A pentathlete is permitted to wear socks with a turnover showing the colours of their national team 10 cm high.

3.1.4

The Glove

- i) The gauntlet of the glove must, in all circumstances, fully cover approximately half the forearm of the pentathlete's sword arm to prevent the opponent's blade entering the sleeve of the jacket.
- ii) The glove on the gauntlet must not be covered by material that can cause the point to glance off.



3.8 EQUIPMENT

3.8.1

The Mask

- i) The mask must be made with mesh (space between wires) of maximum 2.1mm and from wires with a minimum gauge of 1mm diameter.
- ii) The mesh must withstand, without permanent deformation, the introduction into the mesh of a conical instrument, the angle of the surface of the cone being at 4° to the axis and a pressure of 12kg.
- iii) The bib of the mask must be made with cloth resistant to 1600 Newtons. Only masks with two independent security devices will be allowed for use at all UIPM competitions. The mask must not be covered, in whole or in part, by material that can cause the point to glance off it. The mask must be so shaped that the bib reaches below the prominence of the collarbones (clavicles).
- iv) A mask which does not comply with the safety requirements laid down in this article will be visibly rendered unusable by the weapon checking personnel.
- v) The mesh part of the mask can be painted in two different ways:
 - painting the mesh with the colours of the nation of the athlete or
 - exact mirroring the nation's flag of the athlete on the mesh of the mask.No other way of painting on the mask is allowed to use at the competitions.

3.8.2

The Épée

- i) Weight and length
 - a) The total weight of the épée ready for use must be less than 770 grams.
 - b) The total maximum length of the épée is 110 cm.
- ii) The Blade
 - a) The blade, which is triangular in section, without cutting edges, is made of steel and must be complying with safety standards
 - b) There are two methods of manufacture (see Figure 4):
 - 1) By forging a steel cylinder (Cross – section of blade, A);
 - 2) By folding a sheet of steel (Cross – section of blade, B).
 - c) It should be straight as possible and be mounted with the groove uppermost. Any curve of the blade must be uniform and the maximum bend must in any case be less than 1cm; it is only permitted in the vertical plane and must be near to the centre of the blade.
 - d) The maximum length of the blade is 90 cm and the maximum width of any of the 3 sides of the blade is 24 mm.
 - e) The blade must have a flexibility equivalent to a bend of 4.5 cm minimum and 7 cm maximum, measured in the following way:
 - 1) The blade is fixed horizontally at a point 70 cm from the extremity of the button.
 - 2) A 200grams weight is suspended 3 cm from the extremity of the button.
 - 3) The bend of the blade is measured at the extremity of the button between the non-weighted and the weighted position (See Figure 4).
 - f) Treating a blade between the guard and the tip (button) by grinding, filling or other methods, is forbidden. Sharpening the edges or angles of the point is forbidden.
 - g) At UIPM Category "A" competitions, all individual equipment must fulfil the FIE competition requirements. Only FIE homologated maraging blades are permitted. Note: N = non-maraging steel; and are not allowed at UIPM Category "A" competitions.
 - h) Fencing in other UIPM competitions non-maraging steel blades are allowed, but must comply with current safety standards.
- iii) The Electric Wires
The épée has 2 electrical wires, glued in a groove in the blade, which connect the button of 2 of the 3 sockets situated inside the guard and which forms the active circuit of the épée. The body of the épée is connected to the third socket.

- iv) The Guard
- a) The convex face of the guard must be of a shape and surface that is both smooth and not too bright. It must be made in such a way that it can neither hold nor catch the opponent's point. It must not have a raised rim. The guard, which must have a circular edge, must be able to pass through a cylindrical gauge having a diameter of 13.5 cm and a cylindrical length of 15 cm, the blade being parallel to the axis of the cylinder. The depth of the guard (the distance between lines 'b' and 'c') must be between 3 and 5.5 cm.
 - b) The total length between lines 'a' and 'c' must never be greater than 95.5 cm. Eccentric mounting is allowed provided the distance between the centre of the guard and the point where the blade passes the guard does not exceed 3.5 cm.
 - c) Inside the guard there must be a cushion (padding) of sufficient width to protect the electric wires from the pentathlete's fingers. The padding on the inside of the guard must be less than 2 cm thick and must be arranged so as not to increase the protection that the guard affords the hand. The connections must be so arranged that it is impossible for the pentathlete to break or make contacts while fencing.
 - d) The two wires must be protected by insulating sheaths, one on each wire. Both the wire and insulating sheaths must go right up to the socket. In no case may non-insulated wires project beyond the point where they are attached to the socket.
 - e) Any system of attachment inside the guard is allowed, provided that it conforms to the following requirements:
 - 1) It must be easy to detach or attach the body wire;
 - 2) it must be possible to check it by a simple method such as using a penknife or a knife;
 - 3) it must be easy to apply the point d'arrêt of the opponent's weapon to the earth circuit connected to the blade;
 - 4) it must have a security device, which makes it impossible for the contact to be broken during the bout;
 - 5) it must ensure the complete connection of the electric wires; it must be impossible for even a momentary break of contact to occur while the plugs are connected;
 - 6) it must not include any part that allows electrical contact to be made between the plug sockets.
 - f) The maximum electrical resistance allowed on épée is 2 ohms.
 - g) Those who wish to assemble electric weapons, but who are not equipped to undertake electrical tests, are advised that the limits for the electrical resistance for the circuits laid down for each weapon have been fixed so that they can be attained by anyone who is reasonably careful. They are advised:
 - 1) thoroughly to de-oxidise the external surface of the guard and the connecting surfaces inside it;
 - 2) not to destroy the insulation of the wires, especially where they pass along the groove in the blade at the point and at the guard;
 - 3) to avoid accumulations of glue in the groove of the blade.
- v) The Pointe d'Arrêt and the Button
The electric button is completed by a pointe d'arrêt that must conform to current standards. Only traditional or homologated pointes d'arrêt are accepted. No other kind of pointe d'arrêt, notably new ones that are not homologated, will be accepted.
- vi) Fixing the Button
The base of the button may be made in one piece with the blade or the flattened piece of the tip of the blade retained. The button must be screwed



onto the end of the blade, which must be cut and threaded for this purpose, under the following conditions:

- a) Normally, only fixing by metal-to-metal to the end of the blade is allowed. Fixing by insulating material is forbidden.
- b) Any method of soldering or brazing or any heating in general that may affect the temper of the blade is forbidden. Only a solder of very easily melted tin used with a soldering iron to prevent the tip from coming loose is authorised.
- c) The end of the blade before cutting the thread must not have a diameter at any point of less than 4mm, and this without anything being wrapped around it, a process which is strictly forbidden.
- d) The diameter of the core of the thread must not be less than 3.05 mm (thread SI. 4.0 x 0.70).

vii) The Grip

- a) The maximum length of the épée's grip is 20 cm, measured between lanes 'b' and 'e', and 18 cm between the lanes 'b' and 'd' (See Figure 4).
- b) The grip must be able to pass through the same gauge as the guard. It must be made in such a way that it normally cannot injure either the user or his opponent. All types of grips are allowed providing that they conform to the rules, which have been framed with a view to placing the various types of weapons on the same footing. Orthopaedic grips, whether metal or not, may not be covered by leather or any material which could hide wires or switches.
- c) The grip must not include any device that assists the pentathlete to use it as a throwing weapon. The grip must not include any device that can increase in any way the protection afforded to the hand or wrist of the pentathlete by the guard. A cross bar or electric socket that extends beyond the edge of guard is expressly forbidden.
- d) If the grip (or glove) includes any device or attachment or has a special shape (orthopaedic) that fixes the position of the hand on the grip, the grip must determine and fix one position only for the hand and grip. When the hand occupies this position on the grip, the extremity of the thumb when completely extended must not be more than 2 cm from the inner surface of the guard. It is forbidden to have devices that attach the grip to the hand since this would result in extra strength and possible risk of injury to the opponent. The use of grips such as the *gardère* or other similar grips is forbidden, provided that this rule does not prohibit the use of the grip conventionally known as the orthopaedic grip.

3.8.3 THE BODYWIRE

- i) The conductive wires of the body wire as part of the pentathlete's personal equipment must be well insulated from each other, insensitive to humidity and either joined or twisted together. The maximum electrical resistance allowed for each of these conductive wires from plug to plug is 1 ohm.
- ii) The body wire must have a connecting plug on each end. At the spool end, a three pin male plug must be connected to the wire as follows:
 - a) The pin 15 mm from the centre pin to whichever wire is most directly connected to the point d'arrêt;
 - b) The centre pin to the other wire of the épée;
 - c) The pin 20 mm from the central pin to the épée's earth circuit and to the conductive piste.

PART B

EQUIPMENT AND FACILITIES PROVIDED BY THE LOC

**3.9
FOP AND piste**

**3.9.1
The FOP**

The field of play should have an even surface. It should give neither advantage nor disadvantage to any pentathlete, especially as regards to lighting. The fencing area inside the FOP must be restricted only to the pentathletes and judges.

**3.9.2
The Piste**

That portion of the field of play which is using for fencing is called **the piste** (See Figures 1 and 2).

- i) There should desirably be a sufficient number of pistes to run the events with the athletes/teams/groups paired. The pistes are lettered starting in A and placed in the FOP in such a way that the teams, after each round, will change to the neighbouring piste. One reserve piste must be provided.
- ii) A conductive piste must be made from metal, metallic mesh or some substance with a base that is conductive.
 - a) The resistance of the piste, from one end to the other, must not exceed 5 ohms.
 - b) The piste is from 1.50 metres to 2.00 metres wide.
 - c) The piste is 14 metres long, so that each pentathlete being placed at 2 metres from the centre line has at his disposal for retreating a total distance of 5 metres without it being necessary for him to cross the rear limit of the piste with both feet.
- iii) **Five lines** should be drawn very clearly on the piste at right angles to its length, as follows:
 - a) One centre line that must be drawn as a broken line across the whole width of the piste;
 - b) two on-guard lines at 2 metres on each side of the centre line. These must be drawn across the whole width of the piste;
 - c) two lines at the rear limits of the piste, which must be drawn across the whole width of the piste, at a distance of 7 metres from the centre line. In addition, the last 2 metres of the piste before these rear limit lines must be clearly distinguished.
 - d) If possible by a different colour of piste – to make it easy for the pentathletes to be aware of their position on the piste.
 - e) If the last 2 metres of the piste is the same colour, the last 2 m must be clearly marked alongside of the piste with a different colour to the floor.
- iv) The conductive piste must cover the whole length and breadth of the piste including its extensions. When the piste is mounted on a platform the conductive piste must cover the whole width of the platform. The platform must not exceed 50 cm height and must be wider than the fencing piste itself by at least 25 cm on each side. Each end of the podium must be equipped with a gentle slope down to the ground level.
 - a) An extension of 1.50 metres to 2 metres is added at each end of the piste on which the pentathletes can retire. The conductive piste must therefore have a total length of 17 to 18 metres.
 - b) The paint used to draw the lines on the conductive piste must not prevent its electrical conductivity so that a hit made on it where a line occurs is also neutralised.
 - c) The Organising Committee must have equipment available on the spot for the immediate repair of the piste.
 - d) There must be no roller or any sort obstacle at the ends of the conductive piste, which could prevent the pentathletes from retreating normally.



3.10 OTHER EQUIPMENT

3.10.1 SCORING APPARATUS

- e) The table or support on which the judging apparatus is placed should stand opposite the central lane and at least 1 metre from the piste.
 - f) One or more pistes must be available as reserve pistes to be used when one or more matches are slower than the rest.
-
- i) There must be one **central judging apparatus** with extension lamps for each piste.
 - a) Only an electrical apparatus designed with wires connecting the pentathletes to the central apparatus and registering hits by a light signal with auxiliary sound signals are authorised. The apparatus registers when contact is established between the wires forming the circuit in the épée, thus completing the circuit.
 - b) The apparatus must register only the first hit that is made. In case the interval of time between 2 hits is less than 40 milliseconds (1/25 of a second), the apparatus must register a double-hit. Then both signal lamps must light up simultaneously. When the interval is greater than 50 milliseconds (1/20 seconds) the apparatus must register only one hit. Then only one signal lamp is lit. The tolerance allowed for timing the apparatus is that between these two limits (1/25 seconds and 1/20 seconds).
 - c) When the external resistance is normal, that is 10 ohms, the apparatus must register hits when these are made with duration of contact of 2 - 10 milliseconds. With one exceptional external resistance of 100 ohms the apparatus must still register a hit, but without any specific duration of contact.
 - d) The apparatus must not register hits that are made on the earthed material (on the guard or on the conductive piste), even when there is a resistance of 100 ohms in the earth circuit. The apparatus must not register a hit made in the metallic piste or on the metallic parts of the weapon, nor may it prevent the registering of a hit made simultaneously by the opponent.
 - ii) The apparatus must be based on an **electrical supply** of 12 volts. The electrical connection on the apparatus provided to connect it to the supply must be so constructed that it is impossible to connect the apparatus by mistake to the general supply (mains). If the apparatus is constructed for use with dry batteries, it must be equipped with a voltmeter or other device whereby the state of the dry batteries can be checked at any time. Nevertheless, the apparatus must always be provided with the electrical connection prescribed above to enable it to be supplied by batteries.
 - iii) The apparatus must include a **warning light** to indicate that the apparatus is under tension and this lamp should be colourless.
 - iv) **Visual signals** include at least 2 signal lamps on each side of the apparatus, so designed that if one lamp does not function it does not prevent the other from lighting up nor cause an excessive current through the latter. The signal lamps should give a red signal on one side of the apparatus and a green signal on the other. The apparatus may include lights that indicate shorts to the earthed circuit; these should be orange in colour. The light bulbs, which show when hits are registered, are usually covered with translucent shades. It must, however, be possible to remove these shades and use the naked lights when the lighting conditions in the locality make it desirable to do so (strong sunlight or, exceptionally, in the open air).
-
- a) The signal lamps must be placed on top of the apparatus in order that they may be simultaneously visible to the Referee on the piste, the pentathletes and the superintendent of the apparatus. They must be so positioned that they show clearly from which side the hit was made. Arrangements must be made so that extension lamps can be added to the exterior of the apparatus in order to increase the visibility of the signals.

- b) However, should there be a difference between the signals given by the lamps on the apparatus and those given by the extension lamps, the signals by the apparatus are decisive.
- c) Once the signal lamps are alight they must remain so until the apparatus is reset, without having any tendency to go out or to flicker either when subsequent hits are made or if the apparatus is subjected to vibrations.
- v) The visual signals must be accompanied by an **audible sound**. For this the apparatus must have a loud sound signal. The resetting switches must be placed either on top of or in front of the apparatus. The apparatus may include a device which allows the sound signal to be stopped before the apparatus is reset.
- vi) There must be a source of electrical current (batteries) for each apparatus, and a sufficient number of batteries in reserve.

3.10.2 SPOOLS

- i) At official UIPM Category "A" competitions at least **2 spools** with complete cables and connections for each apparatus must be provided at each end of the pistes. This is also recommended for other official UIPM competitions.
- ii) The maximum electrical resistance of each wire of the spool, measured from socket to socket, must be 3 ohms. There must be no interruption of electrical contact even when the spool is being rotated at full speed. To ensure this, contact rings must have double brushes. The wire connected to the blade of the épée will be connected on the frame of the spool.
- iii) The spools must allow 20m of cable to be unwound without straining the springs.
- iv) The socket which terminates the spool cable, and is designed to receive the plug of the body wire plug at the pentathlete's back, must include a safety device which guarantees that it is impossible to use it unless the plug is correctly put in, that it is impossible for it to become separated during the bout and that it is possible for the pentathlete to verify that the 2 previous requirements are satisfied.
- v) The resistance of each of the 3 wires in the connecting cables must not exceed 2.5 ohms.
- vi) The plugs used to connect the body wire to the spool wire and the connecting cables to the spool and to the apparatus must have 3 pins of 4 mm diameter arranged in a straight line.
- vii) The body wire and the connecting cables must have plugs, the spool wires and the electrical central apparatus must have sockets to them.

3.11 THE LOC CONTROL DEVICES AND TOOLS

The LOC must provide the equipment, devices and tools to check the clothing and equipment of the pentathletes as specified in the following and shown in figures 4, 5, 6, 7, 8 and 9.

3.11.1

One gauge allowing measuring the **physical dimensions of the weapons**, lengths of blades and the depths and diameters of the guards at all weapons to be measured quickly.

3.11.2

Devices for measuring the **flexibility** of blades, the **resistance of the mesh** of masks and the **total height** of the épée.

3.11.3

An **electrical checking device** to check quickly that the electrical resistance of the point is not too high, and that the bodywire and the weapon are correctly assembled. Devices enabling these measurements to be taken easily are, in fact, commercially available.

2.11.4

Weights of 750 grams supplied by the LOC to test the pressure of the spring of the points of the épée, in the workshop and at each piste, consists of a metal cylinder drilled part of the way along its axis with a hole parallel to its sides; this hole, into which is inserted the end of the blade, must have an insulating lining to prevent its metallic parts coming into contact with the earthed mass of the épée which might then give a false result to the test. The weight may have a tolerance of ± 3 g, i.e. 747–753 g.

**3.11.5**

A **device** allowing the lighting stroke and residual **travel of epee points** to be accurately measured, in the workshop and at each piste.

- i) The Referee will check the total travel and the residual travel of the pointe d'arrêt and the pressure of the spring;
- ii) He will check the total travel by inserting a gauge measuring 1.5 mm between the barrel of the pointe d'arrêt and the tip. This gauge, provided by the Organizing Committee, may have a tolerance of ± 0.05 mm, i.e. from 1.45 mm to 1.55 mm.
- iii) He will check the residual travel by inserting a gauge measuring 0.5 mm between the barrel of the pointe d'arrêt and the tip. The apparatus should not register when the point is depressed. This gauge, provided by the Organizing Committee, may have a tolerance of ± 0.05 mm, i.e. from 0.45 mm to 0.55 mm;

3.11.6

Labels to indicate that a weapon has been checked and that it satisfies the regulation, or has been rejected.

3.11.7

A **special ink or paint** must be provided to mark the guards, blades and points of weapons which have been checked. Nevertheless, those responsible may use other methods to mark the weapons.

3.11.8**Other equipment and tools**

The LOC must be equipped with the sufficient tools to prepare the pistes, the apparatus and the electric connections. The LOC must also provide tables or supports for the apparatus and 2 chairs in each top of piste.

3.11.9**Fencing Bonus Round**

Equipment and Facilities provided by the Organiser shall include, at minimum,

- i) one Fencing Piste placed on a platform (see Article 2.3.2)
- ii) one scoring apparatus with extension lamps (see Article 2.4.1). Additional repeater lights (e.g. on the piste) and screens are recommended to improve spectator view and information. Ideally LED screens are used, displaying in several directions.
- iii) two spools with complete cables and connections (see Article 2.4.2) for Individual and four spools with complete cables and connections for Relay
- iv) gauge and test weights (see Article 2.5)
- v) table for the scoring apparatus
- vi) enough chairs in the call area for the athletes and two chairs beside the piste for the next competitors
- vii) two chairs for the referee's assistants
- viii) In case of rain, the Organiser shall arrange provision of coverage for the piste and platform, ideally a clear roof on pillars
- ix) a warm –up area to allow each pentathlete/team 15 minutes warm-up prior to their bout.

Figure 1.
piste for semi-finals
and finals (maximum
height 50 cm)

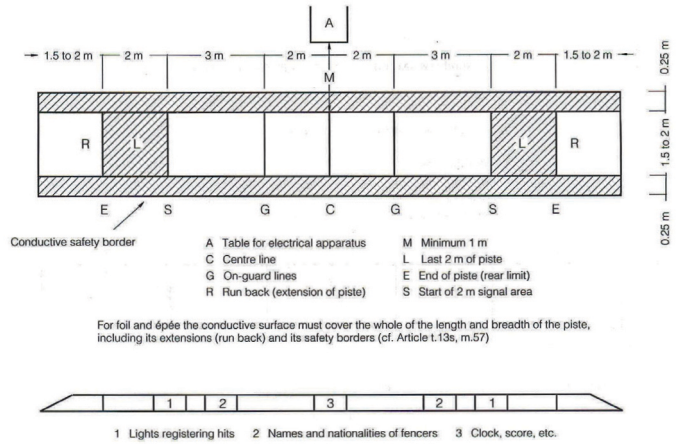

Figure 2.
Standard piste for all
three weapons

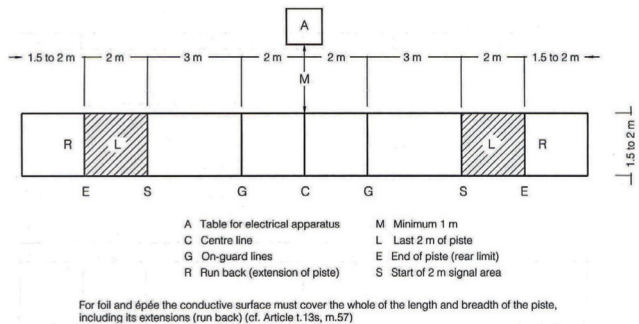



Figure 4.
Epée dimensions for flexibility

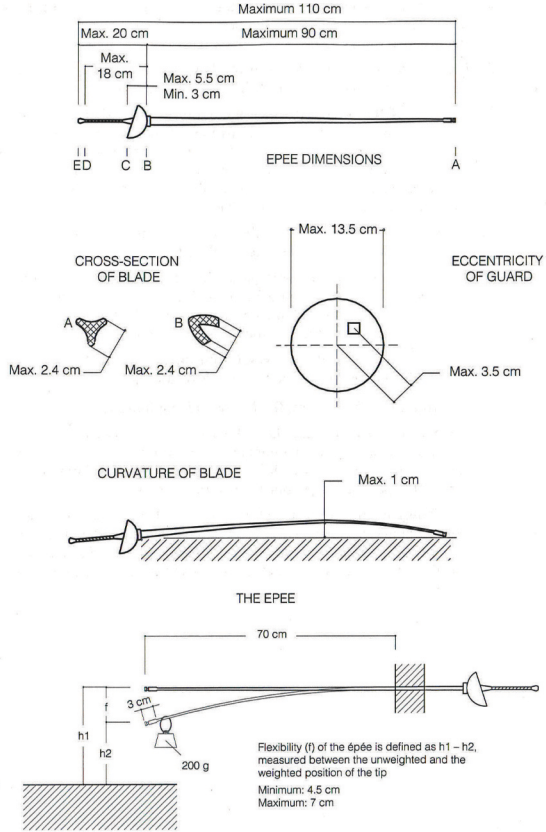
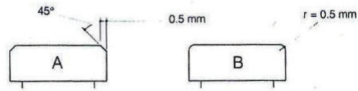
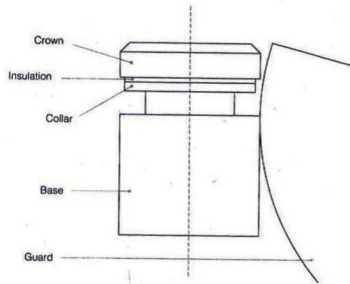

Figure 5:
The point d'arrêt and
the tip of point



Epée: design of pointes d'arrêt



Epée: details of tip of point

Figure 6:
Shape of non-orthopedic grip

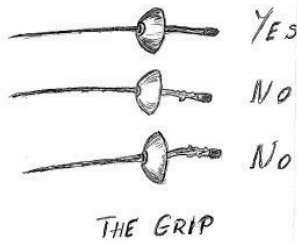
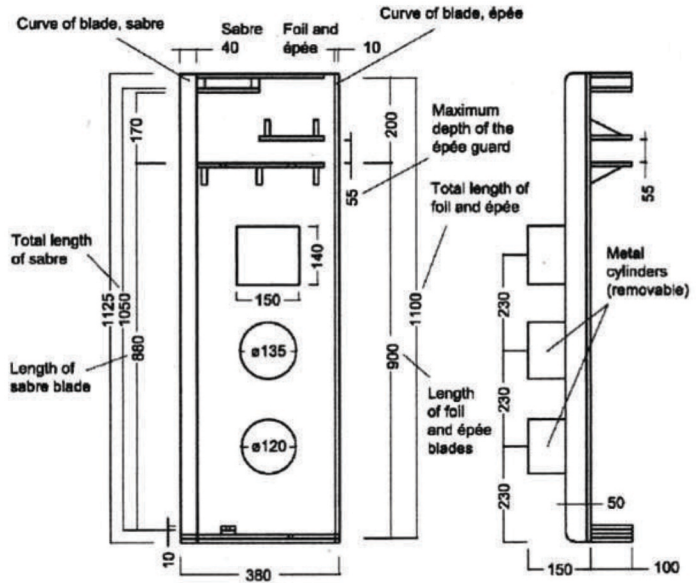



Figure 7:
Gauge for checking
weapons



Dimensions in mm



Gauge to check the
eccentricity of épées
(Tolerance = 10/12 mm)

Diameter = 135 mm

Notes: To carry out the checks properly and rapidly, 'workshop' teams of three people should be used. (At least two such workshops should be provided.)

1. The first person checks that all the weapons are normal with respect to their dimensions by passing them through a gauge.
2. The second does all electrical tests.
3. The third affixes the checking marks and replaces the weapons in the fencing bag.

Figure 8:
The weight to check
the pressure of the
spring of the point of
the epee

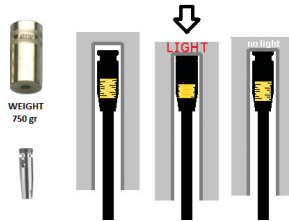

Figure 9b:
The point travels
check

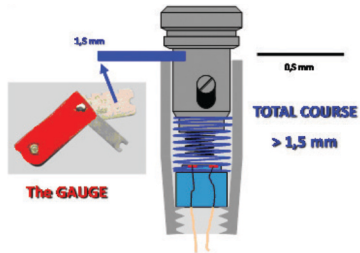

Figure 9a:
The point travels
check

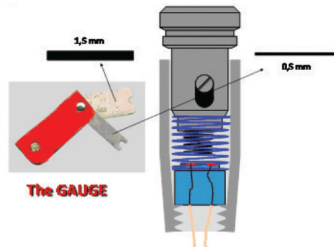
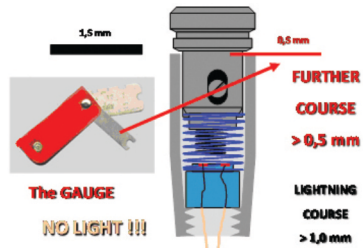

Figure 9c:
The point travels
check



04

EQUIPMENT REGULATIONS



SWIMMING

PART A

THE EVENT

4.7 SWIMWEAR

- | | | | |
|---|------------------|---|---------|
| 1 | Conditions | 4 | Devices |
| 2 | Number of Pieces | 5 | Tape |
| 3 | Dimensions | | |

PART B

EQUIPMENT PROVIDED BY THE LOC

4.8 THE POOL

- | | | | |
|---|-----------------|---|-------------------|
| 1 | Pools | 4 | Water Temperature |
| 2 | Number of Lanes | 5 | False Start Rope |
| 3 | Starting Blocks | | |

SWIMMING

PART A INDIVIDUAL EQUIPMENT

4.7 SWIMWEAR

Only swimwear approved by FINA as set out in its published list of approved swimwear in the preceding and current year may be worn in an UIPM Category A and B official competition. In addition, the pentasuit also can be worn at Swimming. The UIPM logo patch must be placed on the swimsuit/pentasuit according to the current version of the UIPM Uniform Guideline. Missing or wrongly placing of the UIPM logo patch will be penalised by deduction of 10 points.

4.7.1 Conditions

All pentathletes swimwear/pentasuit must be in good condition and non-transparent.

4.7.2 Number of Pieces

In Swimming competitions, the competitor must wear only one swimsuit/pentasuit in one-piece for male and one or two pieces for female. No additional items, like arm bands or leg bands shall be regarded as part of a swimsuit. Except the pentasuit no Zipper or other fastening system is allowed.

4.7.3 Dimensions

Swimwear for men shall not extend above the navel or below the knee, and for women, shall not cover the neck, extend past the shoulder, nor shall extend below knee. All swimsuits/pentasuits shall be made from textile materials.

4.7.4 Devices

No swimmer shall be permitted to use or wear any device or swimsuit/pentasuit that may aid his/her speed, buoyancy or endurance during a competition (such as webbed gloves, flippers, fins, etc.). Goggles and caps may be worn.

4.7.5 Tape

Any kind of tape on the body is not permitted unless approved by the UIPM Technical Delegate, or where applicable, the UIPM Medical Director (in accordance with FINA Rules).

PART B EQUIPMENT PROVIDED BY LOC

4.8 THE POOL

A video camera must be provided by the LOC for recording the starts. In case of discrepancy the video decides.

4.8.1 Pools

At official UIPM competitions, pools of 50m, 33m and 25m length may be used upon agreement by the UIPM EB. When touch panels for electronic timing equipment are used on the starting end, or additionally on the turning end, the pool must be of such length that it ensures the required distance between the two panels. Ideally the pool is 1.80m deep throughout, but must be minimum 1.35m depth at the starting blocks.

4.8.2 Number of Lanes

- i) The minimum number of lanes in a pool of 50m must be 8. Each must be 2.5m wide with 2 spaces of 50cm width each outside of lanes 1 and 8 respectively.
- ii) Next to each starting block the LOC must provide a box for the athlete to put his clothes before the start.

4.8.3 Starting Blocks

The height of the starting blocks above the water surface may be from 0.5m to 0.75m. The surface area must be at minimum 0.5m x 0.5m. The surface must be covered with non-slip material. The maximum slope is 10 degrees. The starting blocks must be clearly numbered on all four sides. Lane n^o1 is on the right side of the pool, when facing the water from the start top.

4.8.4 Water Temperature

The water temperature shall have a temperature of 25-28°C During the competition, the water in the pool must be kept at a constant level, with no noticeable movement.

4.8.5 False Start Rope

A false start rope should be hung across the pool not less than 1.20 meters above the water level from fixed points placed 15.00 meters in front of the starting end.

05

EQUIPMENT REGULATIONS



LASER RUN

RUNNING/SHOOTING

PART A

INDIVIDUAL EQUIPMENT

5.7 CLOTHING

5.8 EQUIPMENT – THE PISTOL

PART B

EQUIPMENT PROVIDED BY THE LOC

5.9 THE FOP

- 1 The Venue
- 2 The Different Areas

- 3 The Running Course
- 4 Shooting Range Requirements

5.10 OTHER EQUIPMENT

- 1 Target Requirements
- 2 Laser Hit Target
- 3 Laser Hit/Miss Target

- 4 Laser Precision Target
- 5 Indicators (Result Display Lights)

5.11 LOC CONTROL DEVICES AND TOOLS

FIGURES

- | | |
|------------------|---|
| Figure 1 | Indoor or Night Range Light Requirements (in Lux) |
| Figure 2 | The Pistol Grip |
| Figure 3 | Bends in the Grip |
| Figure 4 | The Thumb in the Grip |
| Figure 8 | Laser Target |
| Figure 9 | Laser Precision Target |
| Figure 10 | Indicators (Result Display Lights) |
| Figure 11 | The Precision Target |

LASER RUN

PART A

5.7 CLOTHING

INDIVIDUAL EQUIPMENT

- i) A pentathlete must wear athletic clothing. In Category A competitions, pentathletes from the same country must wear matching uniform.
- ii) The pentathlete must wear a top or pentasuit with their name clearly visible and professionally made, printed or embroidered, on the back of the top or pentasuit, below which is the NF code, of a size between 7-12 cm and in a contrasting colour to the colour of their shirt or pentasuit.
- iii) The UIPM logo patch must be placed on top/shirt/pentasuit according to the current version of the UIPM Uniform Guideline. Missing or wrongly placing of the UIPM logo patch will be penalised by a deduction of 10 points.
- iv) Pentathletes must compete with athletic shoes, with or without spikes. Any spike restrictions must be advised by the LOC in their invitation letter.
- v) The LOC is responsible for providing every pentathlete with two start numbers.
- vi) Start numbers, indicating the start order are provided by the LOC in accordance with UIPM Visual Guidelines and must be worn by the athletes. Numbers must be worn on front and back above waist height and be visible in all weather conditions. The start numbers can be made of adhesive material.
- vii) The pentathlete or team who is in first place before the Laser Run shall be assigned No 1, the second place pentathlete/team, No 2, and so on.
- viii) No pentathlete will be allowed to take part in a competition without appropriate numbers.
- ix) It is forbidden for pentathletes to modify the dimensions (size and width) of the start numbers given by the LOC.
- x) Wristbands, compressive sleeves, taping or similar items that might provide support to the shooting hand are prohibited on the hand, elbow and arm.
- xi) A sports watch is permitted on the non-shooting hand.
- xii) Radios, tape recorders or any type of sound-producing or communication systems are prohibited. Devices whose sole function is noise reduction may be worn.
- xiii) It is strongly recommended that current Olympic and World Champions wear clothing, vests or armbands which identify their Champion status to spectators.

5.8 THE PISTOL

Laser Pistol

- i) Only single shot pistol is allowed without any form of magazine or clip. The shot must be activated by a mechanical trigger (trigger lever movement). Electronical triggers are forbidden but sensors and actuators for activating the emitting of the Laser signal can be used within the pistol
- ii) The single shot laser pistol must be loaded by a loading lever, which needs to be operated by the non-shooting hand. The loading lever must serve the purpose of loading each (laser) shot. The loading lever must be opened mechanically by hand, and with a movement from 0° to a minimum of 35° before the next shot will be enabled.
- iii) The weight of the pistol with all accessories must not exceed 1500 grams. The minimum weight is 800 grams (tolerance 5%), for Under 17 (YB) Youth competitions 500 grams (tolerance 5%).
- iv) The overall size of the complete pistol is limited to dimensions which permit it to be enclosed completely in a rectangular box with inside dimensions of 420mm x 200mm x 50mm. A manufacturing tolerance of + 1.0mm in the dimensions of the box is permitted. The minimum overall size is 20% of the above dimensions (336mm x 160mm x 40mm) with the same tolerance. In each axes the size of the pistol must be greater than or equal to the Minimum-Dimension.
- v) Only open sights are allowed. Optical mirror, telescope, laser-beam, electronic sights, active lights, activated material (other than by ambient light) or electronically projected dot sights are prohibited. Any aiming device



programmed to activate the firing mechanism or to give an indication to this is prohibited. No protective covering is permitted on front or rear sights. There must be possibility of vertical and horizontal aiming correction.

- vi) No part of the grip or accessories may encircle the hand. The heel rest must extend at an angle not less than 90° to the grip. Any upward curvature of the heel and/or thumb rests and/or downward curvature of the side opposite the thumb is prohibited (see figure 2). The thumb support must allow the free upward vertical movement of the thumb. However, curved surfaces on the grips or frame, including the heel and/or thumb rest (see figures 3 and 4) in the longitudinal direction of the pistol are permitted.
- vii) Only one (1) laser cartridge/ module per pistol is allowed.
- ix) The laser cartridge must carry the UIPM laser signal of 15.6ms laser signal duration, red colour (635 - 650nm), + -10nm. The Laser Power must be in the range of 2.5mW – 3.4mW. The barrel time in the range of 6ms and 10ms The technical specifications concerning the UIPM Laser signal (shot signal) are given in details in the UIPM document "Technical Specifications Laser Shooting" and in the current UIPM Homologation documents
- x) The following items can be tested at competitions by the Equipment Control Section:
 - a) Weight and overall size of pistol.
 - b) Whether the used Laser modules comply with the specified max./ min. Laser power.
 - c) Wavelength of the Laser: 635 to 650nm +/- 10nm;
 - d) The parameters of the embedded and approved UIPM Laser signal, (also called "short Laser signal").
 - e) Beam diameter: max. 6mm at 10 m distance.
 - f) The time the laser beam is released from the pistol, after pushing the trigger, must be between 6ms and 10ms.
 - g) Wire and radio free;
 - h) After approval for the competition the change of any setting for that competition period is blocked.
- xi) Laser security: The used Laser modules comply with Laser class 1 (EN 60825-1:2014/IEC 60825-1:2014, and all updates) in view of the UIPM Laser signal 15.6. The providers are responsible to provide a certificate for each type of the Laser modules they have embedded in their pistols and cartridges intended for the use in Modern Pentathlon.

PART B

EQUIPMENT AND FACILITIES PROVIDED BY THE LOC

5.9

The Field of Play

5.9.1

The Venue

- i) The Laser Run venue is the site on which the Laser Run competition is conducted, and consists of the Laser Run shooting range and the running course. The LOC is responsible for providing a safe and acceptable Laser Run Course.
- ii) The venue must be technically suitable, according to these rules, to allow all the types of Laser Run competition to be held. It must offer the best possible viewing of the competitions to spectators, and fulfil all the requirements of TV coverage taking into account protection against sunlight as specified below under Article 5.9.4.i and 5.10.1. viii) in Modern Pentathlon 2017 Competition Rules.

5.9.2

The Different Areas

- i) There must be the start/finish area, shooting range, last penalties stop area, relay hand-over zone, running course 600m (300m) lap, judges area, coaches area, media and photographers area, spectator areas, as well as buildings and offices necessary for the UIPM and LOC.

- ii) All the areas and most of the running course shall be located on level ground and close together, so as to provide good viewing of competition for the majority of the spectators but without permitting the spectators to access the restricted areas.
- iii) These areas and critical parts of the course must be fenced off in order to prevent pentathletes from being impeded or going off course and to prevent access by unauthorised persons. However, the height and extent of the fencing must be minimised as much as possible to avoid interference to TV coverage.
- iv) There must be sufficient space for pentathletes and competition officials to conduct their required activities and adequate room for team support staff, media, photographers and spectators, and enough space for TV camera crews and their broadcasting facilities without the broadcasting interfering with the competition.
- v) A sheltered area for the pentathletes must be provided by the LOC to protect them from the weather.
- vi) Zones for TV coverage of the competitions will be established on the course, in consultation with the LOC, the UIPM TD/NTO and TV advisor responsible for the event. The primary purpose of the zones shall be to ensure the best possible coverage of the competition and in particular to prevent obstruction of the TV image by non-competing persons.
- vii) Adjacent to the finish zone, a fenced-off area (Mixed Zone) has to be established for TV company representatives, media and photographers to have close contact with the competitors for interviews and pictures after they finish.
- viii) An exclusive seating area for VIPs and Sponsors must be located by the LOC in the place most appropriate for optimal viewing of the event.
- ix) It is recommended that the LOC provides a separate area close to the Shooting Range with 5 – 6 targets for the athletes.

5.9.3 The Running Course

- i) The course must be clearly marked and defined so that a pentathlete is at no time in doubt how to follow the course. The course can be laid out on any kind of surface or surfaces. It must be designed so that there is a minimum risk of injury to the pentathletes without therefore no sharp turns or steep declines.
- ii) The maximum climb of the course is 50 metres.
- iii) The total climb is measured from perpendicular angle from the start area and adding together the total metres of climb from each level.
- iv) The last 30 metres of the course shall be straight and flat and the part of the course from the start line to the shooting place must be large enough to facilitate the start and the approach of the shooting positions.
- v) The course must be marked with a signpost at 300 metres.
- vi) The total course must be wide enough to permit two runners to pass each other at any point on the course.
- vii) The start and finish line must always be in the same area.
- viii) The course must be clearly marked with flags, triangles, barriers, tape etc. and/or marks on the ground so that the direction of the course is always visible for the pentathletes. All angles on the courses in competitions category "A" and "B" have to be marked clearly visible 0.5-1m above the ground, 10m before and 10m after the corner. It is the obligation of the UIPM TD/NTO to check the course.
- ix) The start line and the finish line must be marked by a white line at least 5cm wide on the ground at the place of the start and the finish. It is recommended that a gantry (arch, gate, etc.), vertical poles or something similar also mark the start line and the finish line.
- x) In the Relay competition the start line and the finish line must be a minimum 5m wide. 10m on each side of the finish line must be set for a hand-over zone of 20m length. Thus the dimension of the zone will be 20m x minimum 5m. This zone must be clearly marked by demarcation lines.
- xi) The finish area behind the finish line must be large enough to permit the LOC to take care of the pentathletes having completed the course.
- xii) Access to the finish area with the timing device and timekeepers must be suitably restricted so as not to allow access by pentathletes, media or spectators. Particular attention must be paid to the running shooting zone, to



5.9.4 Shooting Range Requirements

avoid collision between the pentathletes entering the running course after the shooting phase.

- xiii) At all official UIPM Category "A" and "B" competitions a UIPM TD/NTO must inspect and validate the length and path of the course and make changes if necessary. At Olympic Games and World Championships, this inspection must take place at least two days before the start of the competition, in all other competitions, at least one day before the start of the competition.
- xiv) At least 60 minutes before the start of the first discipline of the competition, the course must be marked so it is possible to start the warming-up.
- xv) At least 5 minutes before the start all necessary restrictions must be settled.
 - i) The range can be indoor or outdoor and must be constructed so that direct sun does not disturb the pentathletes. The targets should be positioned so that the sun does not interfere directly with the registering of shots on the targets. The targets shall be placed 1m +/- 15 cm apart from each other.
 - ii) If the venue, the running course and the targets are sufficiently illuminated the Laser Run can be organized at night. (Figure 1)
 - iii) The shooting range must be built in such a way it can guarantee the safety of the pentathletes, coaches, judges and spectators. The firing distance is 10 metres, measured from the firing lane to the target face. $\pm 0,05\text{m}$ is accepted as tolerance.
 - iv) With laser pistols no lateral walls and no back wall are required, but no-access to the range by unapproved people must be in place.
 - v) If the weather forecast is predicted as bad the shooting range must protect the pentathletes from the rain using special roof coverage and a waterproof box to protect the pistols, water, towels and binoculars of the pentathletes located under the shooting table.
 - vi) The shooting range must be prepared in such a way the spectators can enjoy the competition and watch the finish, so with the finish line near the shooting range.
 - vii) During training, warm-up and competition, competitors must enter the range from one side and exit the other side.
 - viii) The shooting station must be marked with numbers of a minimum height of 12cm, corresponding to the firing point number. Shooting station nr 1 must be the farthest away from the starting gates.
 - ix) The pentathlete shooting area (1m +/- 15cm wide x 1.5m deep minimum) must be clearly defined with visible ground painted lateral lines and back line (start line for each running leg). Paint of lateral lines can be replaced by tape or small advertising banner.
 - x) There must be sufficient space (minimum 4m) behind the firing points to allow the pentathletes, before and after each shooting series, to run to their shooting station without disturbing the other pentathletes and to permit the Range Officials and the UIPM TDs/NTOs to perform their duties.
 - xi) Targets must be marked with numbers corresponding to their shooting station number. The numbers must have a minimum height of 25cm to be easily seen under normal shooting conditions with normal vision from the appropriate shooting station and from VIP area, public seats and TV cameras.
 - xii) The LOC must guarantee provision of 2 reserve spare targets, numbered S1 and S2. In case of insufficient number of targets for all the pentathletes, the Laser Run can be organised in two or more series with the top pentathletes competing in the last series.
 - xiii) The targets and all the other equipment (target numbers, results display, target covers, lights) must be fixed in such a manner that they have no appreciable movement.
 - xiv) The height of the target centre must be within the following height measured from level of the floor of the firing point:
 - a) Standard Height Variation: 1.40m +/- 0.05 m
 - b) Horizontal variation: 0.25 m.

- xvi) The firing point must be equipped with:
 - a) a table or bench, about 0.7m – 0.8m high. With laser pistol in the table top there should be a soft pad/foam cushion provided by LOC (\pm A4 size, 8cm height recommended) to avoid disturbances on the system;
 - b) the table must have a protection for the pistol in case of rain (waterproof box) or a place under the table;
 - c) With LPT the shooting position must be equipped with a transparent table top or with a waterproof transparent plastic box to protect the feedback device.
- xvii) Athletes shall maintain a tidy shooting position with only essential equipment on the table. During the actual competition, the shooting table must be cleared of any other items than the pistol of the athlete and the provided protective pad/foam.
- xviii) With Electronic and Laser targets an adequate uninterrupted power backup system (UPS System) allowing a minimum of 20 minutes run of the system must be provided by LOC in case stadium/arena is not already equipped. The power cable must be 3*2.5mm 2 section with a waterproof box equipped with a 20A security. This box has to be fixed on the back side of the wall at minimum 0.5m above ground.

5.10 OTHER EQUIPMENT

5.10.1 Target Requirements

- i) In UIPM Senior A Category competitions laser precision targets are mandatory.
- ii) Only targets homologated by UIPM can be used at Category "A" and "B" competitions and PWR competitions. At the beginning of each season the UIPM publishes a list with the homologation standards, which can be used in Category "A" and "B" competitions.
- iii) In a single Laser target application, the Hit and Hit/Miss targets should be able to operate without any external computer.
- iv) Front target side minimum 170mm * 170mm. The colour of the target centre zone is black (visible dark from 10m distance). The dimension of this area is 59.5mm, with a tolerance of 0.5mm. Target surface must be white so that the black aiming area (centre) is clearly visible under normal light conditions at the appropriate distances. Targets are compliant with 10m Air Pistol Target draw; See also figures, 5,6 and 8.
Max input 24V and all standards concerning power over data networks
- v) The valid zone for a "hit" is described, in detail for each target type in detail below.
- vi) The targets must work in all weather conditions including rain and direct sunlight (max30klx).
- vii) Indoor and Night competitions: The LOC must check whether the targets would be interfered by the used artificial lights (Pre-Test of a target in cooperation with UIPM and the provider).
- viii) No active wireless communication by the individual targets in competition mode. For result presentations purposes, the network computer can serve wireless devices. The network computer must be protected against any external communication-interferences.

This kind of targets detects the presence of a Laser signal only in the black zone of the target. Therefore, a feedback arises only with a hit indication.

- i) The technical requirements are:
 - a) The target must identify the approved UIPM Signal Details are specified within the homologation documents..
 - b) 200ms reaction time max concerning internal/external Light interface;
 - c) A shot that hits the black centre zone is a valid shot.(A minimum of 80% of the UIPM signal duration has to be detected).

5.10.2 Laser "HIT" Target (HT)



- d) Interference from any non-visible light has to be avoided and must be blocked by an IR-filter; Visible light different from the Laser light (wavelength range) should be blocked.
- ii) Specific requirements to all level competitions:
 - a) 1.0mm precision of the laser dot detection at the border line between black and white zone. For a Hit indication, a minimum part of the Laser dot (1mm radius from center point) must be inside of the black aiming area. The valid zone is of diameter 59.5mm (black zone).
 - b) able to be used outdoor.
 - c) external perturbation protected (no reactions caused by incident light, which is different to the UIPM Signal).
Some more details are provided by the technical documents and Homologation documents. ("Technical Specifications Laser Shooting" and the current UIPM Homologation documents),

5.10.3

Laser "HIT/MISS" Target (HMT) (figure 5)

This kind of targets detects the presence of a Laser signal on the target and determines in which zone (black or white), the incident Laser light was detected.

- i) The technical requirements are:
 - a) The target must identify the approved UIPM Signal. Details are specified within the homologation documents.
 - b) 200ms reaction time max concerning Light interface and the data interface (network to the competition server);
 - c) The detection procedure must follow the First-Impact-Detection scheme. A shot that hits the black centre zone first is a valid shot. A shot that hits the white centre zone first is a missed shot.
 - d) able to send data of shots (Hit&Miss results in compliance with the UIPM Open Target Protocol).
 - e) Interference from any non-visible light has to be avoided and must be blocked by an IR-filter; Visible light different from the Laser light (wavelength range) should be blocked.
 - f) Connector for external lights.
- ii) Specific requirements to all level competitions:
 - a) Live display of shots (Hit and Miss) via a data network (UIPM Open Target Protocol).
 - b) Indication of "Hit and Miss" shots on external lights.
 - c) 1.0mm precision of the laser dot detection at the border line between black and white zone. For a Hit indication a minimum part of the Laser dot (1mm radius from centre point) must be inside of the black aiming area. The valid zone is of diameter 59.5mm (black zone).
 - d) able to be used outdoor.
 - e) external perturbation protected (no reactions caused by incident light, which is different to the UIPM Signal).
 - f) competition mode must log all settings and shooting data. All data must be available after the competition for judges' purposes. All targets must have the same behaviour and performance (network management).
 - g) The shooting time starts when the target is hit by the first shot (registered shot, valid or not).

Some more details are provided by the technical documents and Homologation documents. ("Technical Specifications Laser Shooting" and the current UIPM Homologation documents).

5.10.4

Laser Precision Targets (LPT) (see figure 6)

This kind of targets detects the presence of a Laser signal on the target and captures an image of the resulting Laser dot. Image capturing is synchronized with the UIPM-Signal timing. The embedded image processing procedure provides afterwards a precise position information of the dot. Mandatory in Senior A Category competitions.

- i) The technical requirements are:
 - a) The target must identify the approved UIPM Signal and needs synchronization between the Signal and the Laser dot analysis. Details are specified within the homologation documents.
 - b) 200ms reaction time max concerning Light interface and the data interface (network to the competition server).
 - c) The reconstruction procedure must follow the First-Impact-Detection scheme. A shot is valid if after the automatic reconstruction of the calibre 4.5mm from the beam centre impact it hits 7.3 or more. This equals a valid zone of diameter 54.7mm.
 - d) able to send data of shots (X&Y Position of a shot from the impact centre point in compliance with the UIPM Open Target Protocol).
 - e) Interference from any non-visible light has to be avoided and must be blocked by an IR-filter. Visible light different from the Laser light wavelength range should be blocked.
 - f) Connector for external lights.
- ii) Specific requirements to all level competitions:
 - a) Live display of shots on screen in 1/10 units via a data network during warm up (UIPM Open Target Protocol). Result presentations during warm-up by wireless connected devices are recommended.
 - b) Indication of "Hit and Miss" shots on external lights.
 - c) 0,5mm precision of the laser dot detection concerning the x/y coordinate's (it concerns the whole target).
 - d) able to be used outdoor.
 - e) external perturbation protected (no reactions caused by incident light, which is different to the UIPM Signal).
 - f) competition mode must log all settings and shooting data. All data must be available after the competition for judges' purposes. All targets must have the same behaviour and performance (network management).
 - g) The shooting time starts when the target is hit by the first shot (registered shot, valid or not).
- iii) The dimensions of all scoring rings are measured from the outside edges (outside diameter) of the scoring rings (see figure 8).

Some more details are provided by the technical documents and Homologation documents. ("Technical Specifications Laser Shooting" and the current UIPM Homologation documents)

5.10.5 Indicators (Result Display Lights) (see Figure 7)

- i) Indicator Wavelength: Red colour must be 640nm and green colour 520nm. (+/- 20nm.) Indicators must be installed minimum 80cm up to the top of the target.
- ii) For "A" Category competitions, indicators must be clearly visible for the athletes and spectators and should be 55mm diameter with minimum of 120° viewing angle. Background of the indicators must be a contrasting colour. Distance between each red/green lamp must be about 40mm.
- iii) For all other competitions, different indicators can be used but the lights must be clearly visible for Athletes and coaches.
- iv) The electrical interface must comply with the UIPM specifications
- v) Indicators can be placed horizontally or vertically.

Boxes

The LOC must provide boxes in the Shooting Range per station for athletes' use. These boxes are to be removed from the Shooting Range at the start and stored in a safe place until after competition.



**5.11
LOC CONTROL
DEVICES AND TOOLS**

**5.11.1
Control Material**

Clothing control is made by observation, using a ruler if necessary.
For the control of all kind of pistols (Part B, Art. 5.8) the LOC must have: box for dimensions, scale for the weight, ruler, square, angle scale and a system to register and mark the approved pistols.

For the laser pistols and laser cartridges, the LOC/ UIPM must also have instruments to check the laser beam - power, diameter and time - and the power of the battery.

**5.11.2
Built Material and
Tools**

The LOC must have available material and tools to build, maintain and rebuild the FOP as described in Part B (5.3 The FOP and 5.4 - Other Equipment). This includes measuring tapes, rulers, measuring wheels, hammers, tools and equipment to repair the ground, barriers, poles or posts, tape, ink, paintbrush, plastic cones, and so on.

Figure 1
Indoor or Night Range
Light Requirements
(in Lux)

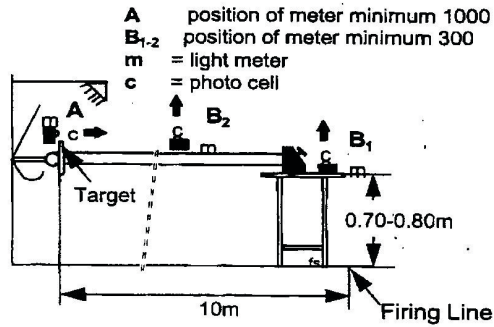

Figure 2
The Pistol Grip

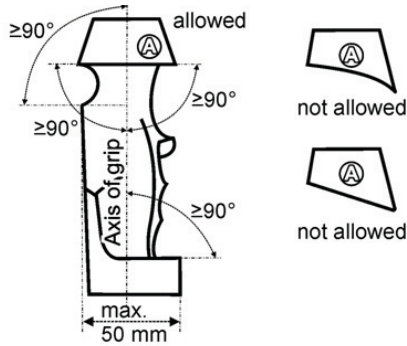

Figure 3
Bends in the Grip

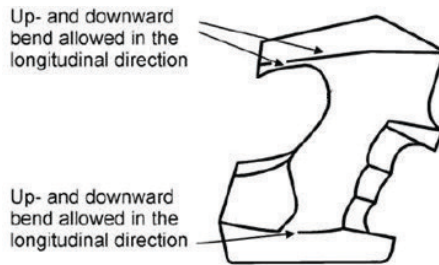
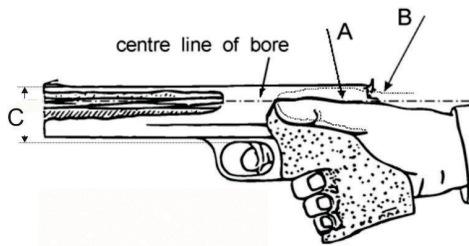

Figure 4
The Thumb in the Grip



Line A ————
Acceptable
Line B - - - -
Not Acceptable

Area C
Laser Light Emmitting Area



Figure 5
Laser Hit-Miss Target
(examples)

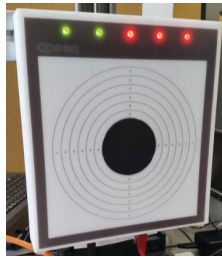
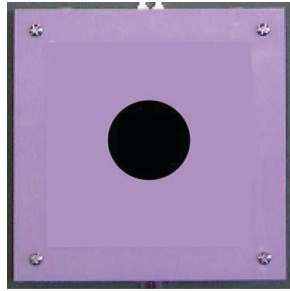
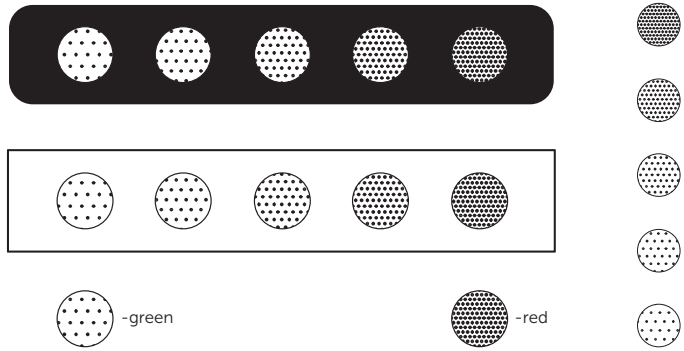

Figure 6
Laser Precision Target
(examples)



Figure 7
Indicators (Result
Display Lights)
(examples)



(Black & white draw for impression B&W)

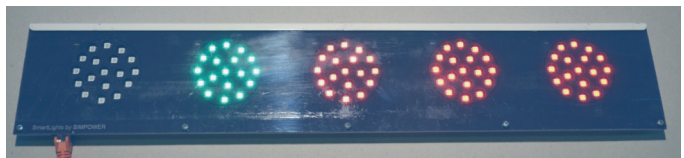
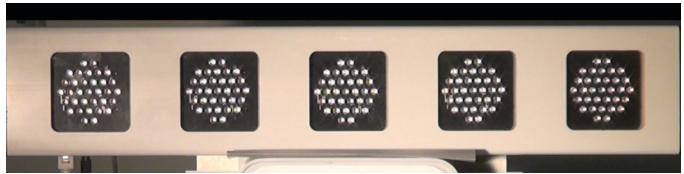
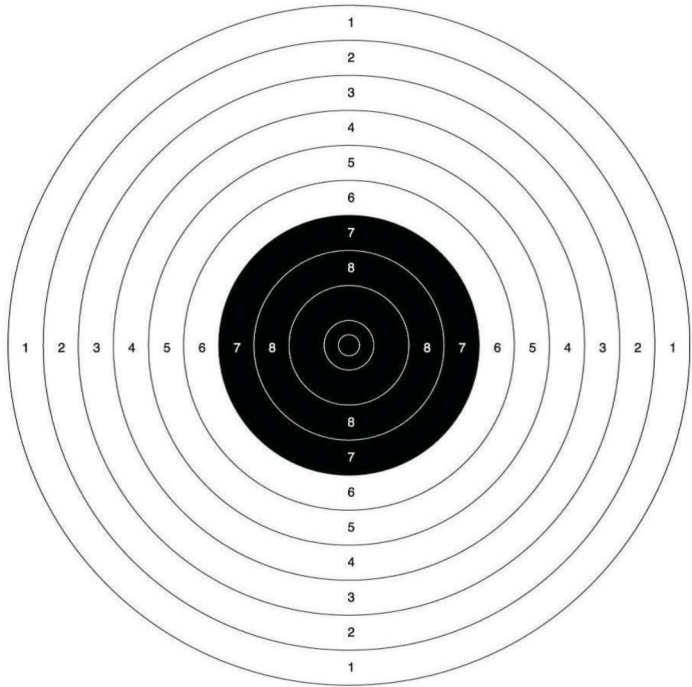



Figure 8
The Precision Target
and Hit-Miss Target

10 ring	11.5 mm (± 0.1 mm)	5 ring	91.5 mm (± 0.5 mm)
9 ring	27.5 mm (± 0.1 mm)	4 ring	107.5 mm (± 0.5 mm)
8 ring	43.5 mm (± 0.2 mm)	3 ring	123.5 mm (± 0.5 mm)
7 ring	59.5 mm (± 0.5 mm)	2 ring	139.5 mm (± 0.5 mm)
6 ring	75.5 mm (± 0.5 mm)	1 ring	155.5 mm (± 0.5 mm)



Central ten: 5.0 mm (+/- 0.1mm)
 Black from 7 to 10 rings = 59.5 mm
 Ring thickness: 0.1 mm to 0.2 mm
 Minimum visible size of target card 170 mm x 170 mm

Hit-Miss Target: Ring values are optional, ring drawings 2 - 6 and 8 - 10 are optional.
Example:

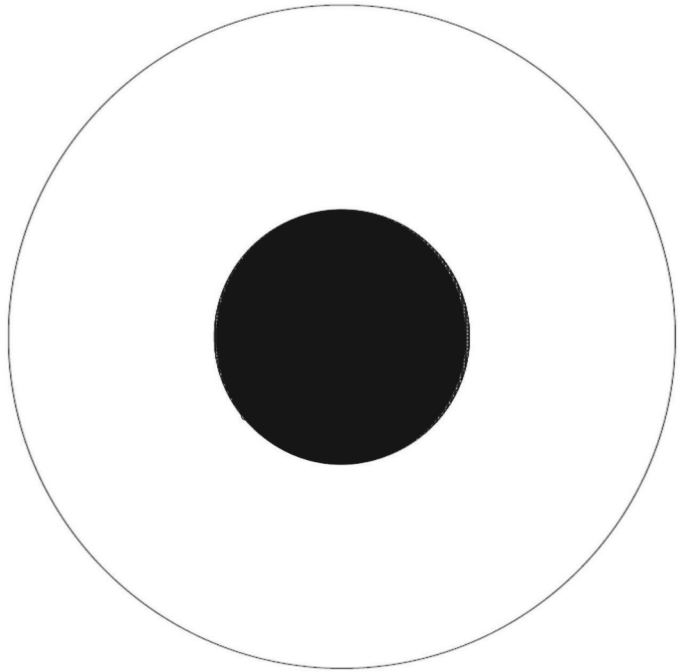





UNION INTERNATIONALE
DE PENTATHLON MODERNE

Union Internationale de Pentathlon Moderne
Stade Louis II – Entrée C
19 avenue des Castelans
MC-98000 Monaco



Web:
pentathlon.org



Facebook:
[/WorldPentathlon](https://www.facebook.com/WorldPentathlon)



Twitter:
[@WorldPentathlon](https://twitter.com/WorldPentathlon)



YouTube:
UIPMTV.org



Instagram:
[/theUIPM](https://www.instagram.com/theUIPM)



Weibo:
[国代五盟](https://www.weibo.com/国代五盟)



VKontakte:
[/worldpentathlon](https://vk.com/worldpentathlon)



UIPM
Central App:
iOS / Android